

## PMH LED 3 colour beacon

- Ø 75 mm LED multi-colour beacon
- Steady light, RED-YELLOW-GREEN, can be switched externally
- Prewired with 1 m PUR cable – ready to use
- High degree of protection IP 66 & IP 67
- Modern LED technology and electronics
- Good signalling effect
- Premounted stainless-steel fixing screws
- 3 types of mounting, for industrial and general applications



### TECHNICAL DATA

Housing	Ø 75 mm, 100 mm High lens , Polycarbonate black (RAL 9005)
Lens	Polycarbonate, ribbed inside clear
Type of mounting	any
Cable entry	pre-wired (1 m cable)
Leakage current	0,003 A (PLC-suitable)
Beacon type	LED multi colour steady beacon
Light source	16 LEDs
Number of colours	3
Duty cycle	100 %
Service life	Light source: >50.000 h
Operating temperature	-30°C/+60°C
Degree of protection	IP66 & IP67
Impact resistance	IK08
Weight	200 g

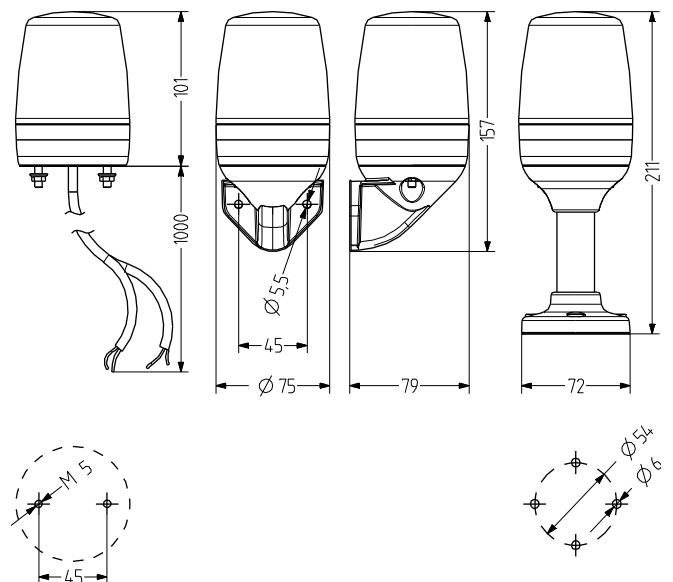

# PMH

## ORDER DATA

Lens colour	Nominal voltage	Voltage range (V)	Nominal current (A)	Order number
clear	24 V AC/DC	16-28 V AC	0,120	860 550 405
		21-35 V DC		
	110-120 V AC	75-132	0,065	860 550 310
	230-240 V AC	140-264	0,065	860 550 313



PMR



PVW



XWR

## ACCESSORIES

Type	Type of accessory	Tube length	Weight	Order number
PMR	Tube base Aluminium tube with plastic foot	100 mm		860 702 900
		250 mm		860 703 900
PVW	Bracket for vertical mounting			860 600 900
XWR	Bracket for vertical mounting of TMR/UMR tube base		95 g	900 600 900

