

	General	194
	Approvals	195
	Informations	196
	Cam Switches	198
	Basic designs	200
	Cam Switches	203
	On-Off switches, Changeover switches	203
	Star-Delta switches	207
	Multi speed switches	211
	Control switches	215
	Voltmeter selector switches	218
	Ammeter switches	219
	Gang switches	221
	Multi step switches	224
	Mini-Cam Switches	236
	Technical data	236
	On-Off switches, Changeover switches	237
	Star-Delta switches	237
	Control switches	237
	Voltmeter selector switches, Ammeter switches	238
	Gang switches, Multi step switches	238
	Load switches	240
	On-Off switches	240
	Changeover switches	241
	Handles and plates	242
	Operating knobs and handles	242
	Escutcheon plates	243
	Standard Markings	244
	Angles of rotation	247
	Optional Extras	249
	Drive units	249
	Door couplings	250
	Key operated switches	251
	Padlock devices	252
	Switch interlocks	253
	Couplings	254
	Accessories	256
	Special switches	257
	Technical data	259
	Cam switches	259
	Load switches	260
	Dimensions	262
	Cam switches	262
	Load switches	266
	Accessories	267

General

Test Authorities, Registration Mark, Approvals

Low voltage switchgear from Benedict GmbH is built and tested to national and international specifications. All devices suit all important specifications without any test obligation, like VDE, BS and also relative to IEC Recommendations and to European Standards like IEC 947 and EN 60947. It is for this reason of our Low voltage switchgear is used all over the world. In order to provide special versions, limitations to the max. voltages, currents and power ratings or special markings are sometimes necessary.

Quality Control System

Since November 1991 Benedict GmbH has been certified according to the quality control system **ÖNORM EN ISO 29001**. The target of the ISO-certification is, to grant the customer the quality of the performance of his supplier, who is audited in accordance with this standard.

CE-Marking



The manufacturer has to sign his products with the CE-Marking. With the CE-Marking the manufacturer confirms the accordance with the different EEC Directives. The CE-Marking is absolutely necessary to sell the products in the EEC.

Below you find the EEC Directives concerning our products.

Low Voltage Directive 2006/95/EC

EMC Directive 2004/108/EC

RoHS + WEEE 2002/95/EC + "002/96/EC

Country	North America	Russia
State deputy or private examination (state admitted)	UL Canada, USA	EAC
Label marking of examination boards	Listed Component	
Duty of approvals	all switchgear	all switchgear

Explanations for choice and supply of low voltage switchgear in Canada and USA

Marking of auxiliary contacts

At several devices in UL-data are two voltages for auxiliary contacts mentioned (e. g.: 600 volts at same potential, 150 volts at different potentials). That means, if the voltage is higher than 150 volts, the control voltage applied to input terminals must be at the same potential.

Low voltage switchgear for auxiliary circuits (e. g. contactor relays, control units, auxiliary contacts in general) usually approved for "Heavy Duty" or "Standard Duty" UL and besides these marked with the admissible max. voltage or with short codes (see table).

Marking of auxiliary contacts according to CSA and UL	Max. rated values per pole			Cont. Current A	Contact Rating Code Designation
	Voltage V	Current Make A	Break A		
Heavy Duty (HD or HVY DTY)	AC 120	60	6	10	A150
	AC 240	30	3	10	A300
	AC 480	15	1,5	10	A600
	AC 600	12	1,2	10	A600
	DC 125	2,2	2,2	10	N150
	DC 250	1,1	1,1	10	N300
	DC 600	0,4	0,4	10	N600
Standard Duty (SD or STD DTY)	AC 120	30	3	5	B150
	AC 240	15	1,5	5	B300
	AC 480	7,5	0,75	5	B600
	AC 600	6	0,6	5	B600
	DC 125	1,1	1,1	5	P150
	DC 250	0,55	0,55	5	P300
	DC 600	0,2	0,2	5	P600
-	AC 120	15	1,5	2,5	C150
	AC 240	7,5	0,75	2,5	C300
	AC 480	3,75	0,375	2,5	C600
	AC 600	3	0,3	2,5	C600
	DC 125	0,55	0,55	2,5	Q150
	DC 250	0,27	0,27	2,5	Q300
	DC 600	0,1	0,1	2,5	Q600
-	AC 120	3,6	0,6	1	D150
	AC 240	1,8	0,3	1	D300
	DC 125	0,22	0,22	1	R150
	DC 250	0,11	0,11	1	R300
-	AC 120	1,8	0,3	0,5	E150

Discernment at UL-Standards

Recognized Component Industrial Control Equipment

UL issues yellow "Guide cards" with Guide- and File-No.

Devices have permission to be marked with the label



Listed Industrial Control Equipment

UL issues white "Guide cards" with Guide- and File-No.

Devices have to be marked with the "UL-Listing Mark"



Devices as components approved for "factory wiring": devices for employment in control panels, when they are selected, mounted and wired according to the charging conditions by skilled worker.

Devices approved for "field wiring",

- a) devices for employment in control panels, when they are mounted and wired by skilled worker.
- b) devices for retail in USA

Valid UL-Standards:
UL 508 "Standard for Industrial Control Equipment" (partly limited)

Valid UL-Standards:
UL 508 "Standard for Industrial Control Equipment" (unlimited)

Are devices approved as "Listed Equipment" the approval is also valid for using as "Recognized Component" .

Approvals

Country	USA, Canada UL	Europe	Russia EAC	CB/CCA- Certificates	China
Type					

Cam Switches (UL-Listed as MANUAL MOTOR CONTROLLER and suitable as MOTOR DISCONNECT)

M10	o	/	o	o	-
M10H	o	/	o	o	o
M20	o	/	o	o	-
N20	o	/	o	o	-
N33F	o	/	o	o	-
N40	-	/	o	o	-
N61	o	/	o	o	-
N80	o	/	o	o	-
N100	o	/	o	o	-
N200	o	/	o	o	-
L400	o	/	-	-	-

o In standard version approved
 - Not provided for test till now

/ No testing required CE

x In test

Contactors, Motor-Starters

Circuit Breakers

Manual Motor-Starters

Switches

AC-Main Switches

DC-Switch Disconnect

Push Buttons

Representatives, Suppliers

Technical Information

Degree of protection acc. to IEC 60947-1

Protection ratings are prefixed by the internationally agreed letters IP followed by two digits.

1st digit: Pertains to solid objects
2nd digit: Pertains to water.

1 st digit	Short description	Definition
1	Protected against solid objects greater than 50 mm	Excludes solid objects exceeding 50 mm in diameter and protects against contact with live and moving parts by a large surface such as a hand (but not against deliberate access).
2L	Protected against solid objects greater than 12,5 mm and against contact by standard test finger	Excludes solid objects exceeding 12,5 mm in diameter and protects against contact with live and moving parts by a standard test finger or similar objects not exceeding 80 mm in length.
3	Protected against solid objects	Excludes solid objects exceeding 2,5 mm in diameter or thickness. greater than 2,5mm
4	Protected against solid objects greater than 1 mm	Excludes solid objects exceeding 1 mm in diameter or thickness.
5	Dust protected	Prevents ingress of dust in quantities and locations that would interfere with the intended operation of the equipment.
6	Dust tight	Prevents ingress of dust.

Resistance to climatic conditions acc. to IEC60068

Open-type devices are climate-resistant in the constant climate according to IEC60068-2-3 (this is a climate with an ambient temperature of 40°C and an atmospheric humidity of 90 to 95%).

Enclosed devices are climate-resistant in an alternating climate according to IEC 68-2-30 (this is a moist alternating climate with a 24-hour cycle between climates with an ambient temperature of 25°C, and an atmospheric humidity of 95 to 100% and an ambient temperature of 40°C, and an atmospheric humidity of 90 to 96% in the presence of condensation during rises in temperature).

Data are valid up to an altitude of 2000m above sea level.

Short circuit protection

Backup fuses should be used to protect contactors and starters against short circuits. For starters the device with the smaller admissible fuse at the main and at the control circuit (contactor or thermal overload) determines the fuse size.

After a short circuit devices have to be checked for correct operation. Disconnect power before proceeding with any work on the equipment!

Mounting positions

No limitations, all kind of positions allowed.













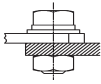

2 nd digit	Short description	Definition
1	Protected against dripping water	Dripping water (vertically falling drops) shall have no harmful effect.
2	Protected against dripping water when tilted up to 15°	Vertically dripping water shall have no harmful effect when the enclosure is tilted at any angle up to 15° from its normal position.
3	Protected against spraying water	Water falling as a spray at an angle up to 60° from the vertical shall have no harmful effect.
4	Protected against splashing water	Water splashed against the enclosure from any direction shall have no harmful effect.
5	Protected against water jets	Water protected by a nozzle against the enclosure from any direction shall have no harmful effect.
6	Protected against heavy seas	Water from heavy seas or water projected in powerful jets shall not enter the enclosure in harmful quantities.
7	Protected against the effects of immersion	Ingress of water in a harmful quantity shall not be possible when the enclosure is immersed in water under standard conditions of pressure and time.
8	Protected against submersion	No ingress of water.

Suitable ambient temperatures:

Operation	open °C	-40 up to +60
	enclosed °C	-40 up to +40
Storage	°C	-50 up to +90

Technical Information

Terminal screws

Devices Type	Kind of connection Screw with washer	2 Screw s		Screw with w. nut	Screw driver	Tightening torque	
						Nm	lb. inch
							
Cam Switches							
M4H..	M2,5	-	-		Pz1	0,6	5
M10	M3	-	-		Pz2	0,6 - 1,2	5 - 11
M10H	M3,5	-	-		Pz2	0,8 - 1,4	7 - 12
M20, N20, N33F	M4	-	-		Pz2	1,2 - 1,8	11 - 16
N40	M5	-	-		Pz2	2,5 - 3	22 - 26
N61, N80	-	2 x M5	-		Pz2	2,5 - 3	22 - 26
N100	-	2 x M6	-		Pz3	3,5 - 4,5	31 - 40
N200	-	-	M10			10	88
L400	-	-	M12			16	140
L600	-	-	M16			24	210
L800	-	-	M16			24	210
L1200	-	-	M16			24	210

Contactors, Motor-Starter

Circuit Breakers

Manual Motor-Starters

Switches

AC-Main Switches

DC-Switch Disconnect

Push Buttons

Representatives, Suppliers

Ratings								Designs			
Typ	Rated current			Motor			Plate mm	Panel moun. M10H, M20 IP65 IP40	Single hole mount. Ø22,5mm with Plate IP65	without Plate IP65	Flush mount. IP40
	Therm. I_{th} open A	AC21 A	at U_e V	AC3 3~400V kW	AC23 3~400V A	3 kW		M4H E	M4H Z	M4H ZO	-
M4H	10	10	440	2,2	6	3	30□	M4H E	M4H Z	M4H ZO	-
M10H	20	20	690	5,5	16	7,5	48□	M10H E	M10H Z	M10H ZO	-
M10	20	20	440	5,5	16	7,5	48□	-	-	-	M10 UP
M20	32	32	690	11	30	15	48□	M20 E	M20 Z	M20 ZO	-
N20	32	32	690	11	30	15	64□	N20 E	-	-	-
N33F	50	50	690	15	45	22	64□	N33F E	N33F Z	-	-
N40	63	63	690	15	45	22	88□	N40 E	-	-	-
N61	90	85	690	25	60	30	88□	N61 E	-	-	-
N80	115	115	690	30	85	45	88□	N80 E	-	-	-
N100	150	150	690	40	110	55	132□	N100 E	-	-	-
N200	250	250	690	70	140	70	132□	N200 E	-	-	-
L400	400	400	690	70	140	70	132□	L400 E	-	-	-
L600	600	400	690	70	140	70	132□	L600 E	-	-	-
L800	800	400	690	70	140	70	132□	L800 E	-	-	-
L1200	1200	400	690	70	140	70	132□	L1200 E	-	-	-

Cam Switches 10 - 250A

Cam switches can be used for virtually all purposes, e.g. as motor, main, control or instrument switches. Over and above the switching programs mentioned in the list, an effectively limitless number of special programs can be implemented.

Load switch L.. 400 - 1200A

Load switches are primarily employed where resistive or slightly inductive current loads are to be switched on and off, or switching takes place without loading.

Load switches are assembled by parallel switching of two or more of cam switch contacts.

With customer built main terminal protection, load switch L.. can also be used as main switch.

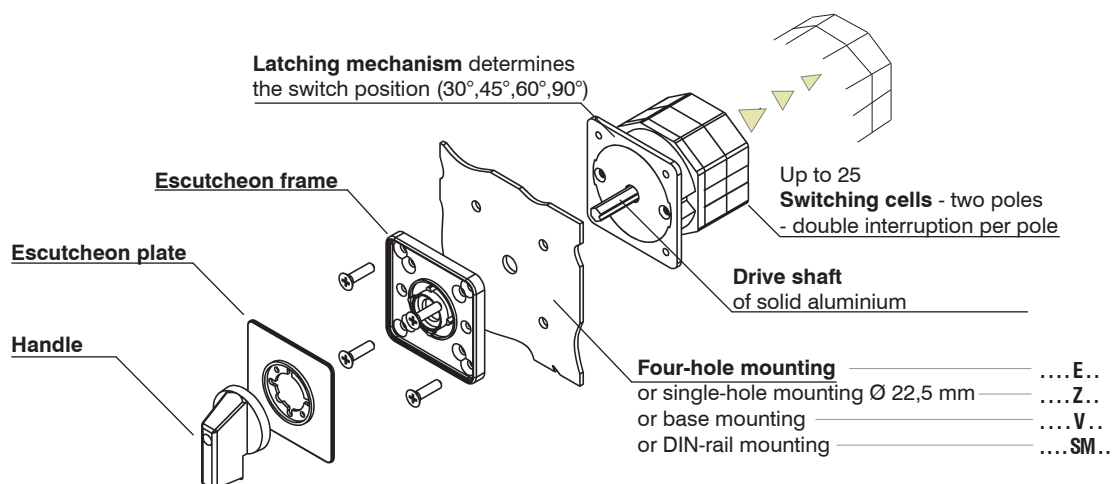

Designs	Base mounting M10H, M20 IP65 IP40	DIN-rail mounting IP40	Modular IP40	Plastic enclosed ..P.. IP40 ..PF.. IP65	horizontal, IP65	Motor switch enclosed IP65	Terminal box mounting IP65
-	-	-	-	-	-	-	-
M10H V ♦	M10H SM ♦	M10H SMA ♦	-	M10 P(F) ♦	-	M10 PM ♦	-
M20 V ♦	M20 SM ♦	M20 SMA ♦	-	-	-	-	M10 KE ♦
N20 V ♦	N20 SM ♦	-	N20 P(F) ♦	-	N20 PM ♦	N20 KE ♦	-
N33F V ♦	N33F SM ♦	-	N33F P(F) ♦	-	-	-	-
N40 V ♦	-	-	N40 P(F) ♦	N40 PLF ♦	-	-	-
N61 V ♦	-	-	N61 P(F) ♦	N61 PLF ♦	-	-	-
N80 V ♦	-	-	N80 P(F) ♦	N80 PLF ♦	-	-	-
N100 V ♦	-	-	-	-	-	-	-
N200 V ♦	-	-	-	-	-	-	-
L400 V ♦	-	-	-	-	-	-	-
L600 V ♦	-	-	-	-	-	-	-
L800 V ♦	-	-	-	-	-	-	-
L1200 V ♦	-	-	-	-	-	-	-

Ordering

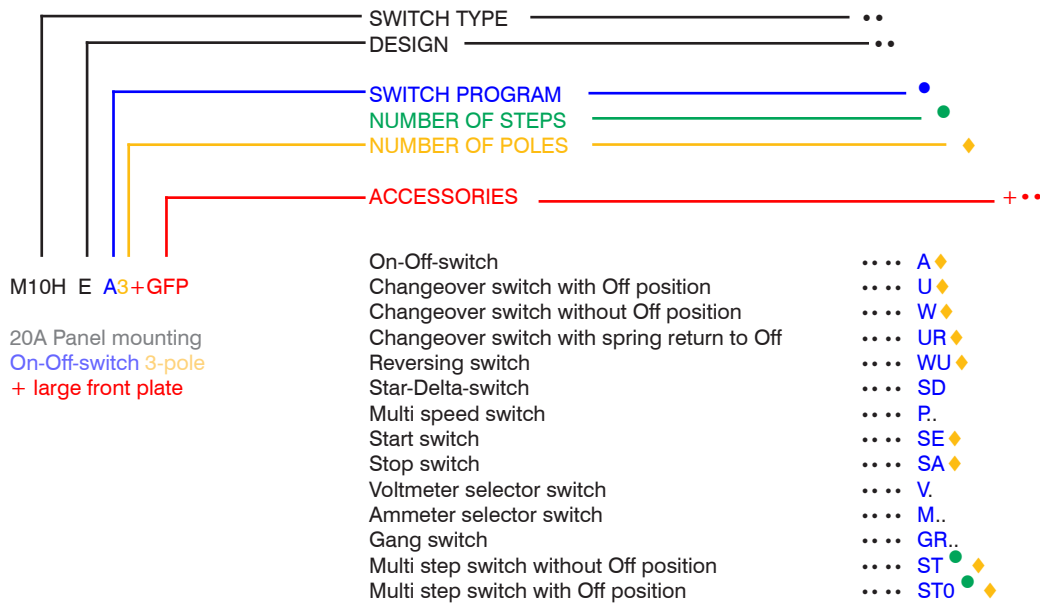

Panel mounting designs

Switches of the panel mounting designs listed below have protection from front IP40. Where a shaft seal (appendix +WD) is used, the protection is increased to IP54. Use of a moisture proofing cap (appendix +FR) results in an increase in rear protection to IP54. In the standard version, the switches are delivered with a square escutcheon plate and black instrument knob. Forward mounting is possible for some of the design

E switches. The position of the terminals of the standard switches is left and right, at switch M10H the terminals are above and below. Where a knob insert is turned by 90° (can easily be performed after delivery), the position of the terminals can be changed.

Dimensions see page 262.



Design

Description	Type appendix	Possible switch sizes					
		M10H	M20	N20 N33F	N40 N61 N80	N100 N200	L...
Panel mounting For installation in control panels, machines and equipment. For panel thickness of over 5mm, an extended switch shaft is required (appendix +VW). Protection from front: M10H, M20 IP65 all others IP40	E	X	X	X	X	X	X
Central fixing 22,5mm Switch for mounting with standard 22,5mm mounting holes and 1-4mm panel thickness. Protection from front: IP65 Wrench J7049 necessary	Z	X	X	X ²⁾	-	-	-
Central fixing 22,5mm Switch without escutcheon plate , for installation with standard 22,5mm mounting holes and 1-4mm panel thickness. Protection from front: IP65 Wrench J7049 necessary	ZO	X	X	-	-	-	-
Flush mounting version Switch with white instrument knob, cream escutcheon plate with black markings, for installation in 65mm flush mounting boxes and use of Unitas plate. Supplied with flush mounting box: appendix +UP. Maximum number of cells with: M10 FM box 45mm deep 2 FM box 65mm deep 4	UP	X ¹⁾	-	-	-	-	-

1) Switches are delivered with switch type M10



2) For switch types N33F only, max. 3 cells

Base mounting designs

Switches of the designs listed below have protection from front IP40. When a shaft seal (appendix +WD) is used, the front protection type is increased to IP54. In the standard version, the switches are delivered with a square escutcheon plate and black instrument knob (design SMA with grey cover and grey toggle knob). Door couplings are advisable for switchgear cabinets with hinged doors.



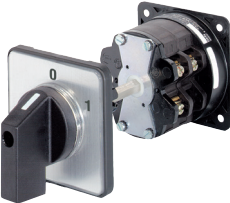
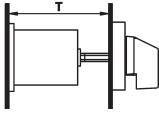

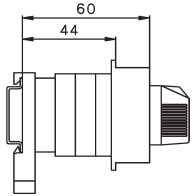
The position of the terminals of the standard switches is left and right, at switch M10H the terminals are above and below. Where a knob insert is turned by 90° (can easily be performed after delivery), the position of the terminals can be changed.

Dimensions see page 263.

Design	Possible switch sizes	Possible switch sizes					
		Type appendix	M10H	M20	N20 N33F	N40 N61 N80	N100 N200
 <p>Base mounting For screw mounting to the back wall or floor of distributor boxes, or of appliances with removable lids. Additional it is necessary to state the installation depth - that is the distance between mounting level of the switch and the inside edge of the door (dimension T).</p>  <p>Door couplings see page 250</p>	V ... +T/...	X	X	X	X	X	X
 <p>Snap-on mounting on DIN-rail with installation cover for standard opening and toggle knob. The lay-out of the terminals of the standard switches is above and below. Dimensions for Switch types M10H SMA .. with 1-3 cells M20 SMA .. with 1 or 2 cells</p>  <p>further dimensions see page 263</p>	SMA	X	X	-	-	-	-

Plastic enclosed switches

The switches, which have durable plastic enclosures, are intended for wall mounting or attachment to machines. In the standard version, they are supplied with a light-grey enclosure, square escutcheon plate, black markings on a silver background, and a black instrument knob. Other colours and colour combinations are available for most enclosure types. It is not possible to mount an additional rectangular plate. The enclosure base is equipped with 4 entry glands with heavy-gauge conduit threads (see drawings). In all types of plastic enclosures, two terminals that are connected and insulated from switch column can be provided for a PE conductor (appendix +PE). **Dimensions** see page 264.

Design	Type appendix	Possible switch sizes						
		M10H	N20	N33F	N40	N61	N80	N100
 <p>Plastic enclosure light grey Protection class IP40 Maximum number of cells</p>	P	X	X	X	X	X	X	-
 <p>Plastic enclosure light grey Moisture protection Protection class IP65 Maximum number of cells</p>	PF	X	X	X	X	-	-	-
 <p>Plastic enclosure horizontal light grey Moisture protection Protection class IP65 Maximum number of cells</p>	PLF	-	-	-	X	X	X	-
 <p>Terminal box mounting Protection class IP65 These switches are front mounted on a terminal box. The switch cells protrude through a hole into the terminal compartment. Maximum number of cells</p>	KE	X	X	-	-	-	-	-
 <p>Plastic motor switch enclosure Moisture protection Protection class IP65 Maximum number of cells</p>	PM	-	X	-	-	-	-	-

Switching programs

Description	Wiring diagram	Switching angle	Number of cells ↓ Size ↓ AC21	Type	Design					Switch pro-	Escutcheon plate	
					E.	Z.	V.	SMA.	P.			
On-Off-switches A												
1-pole		60°	1	48 □ 20A	M10H .	x	x	x	x	x ¹⁾	. A1	
				32A	M20 .	x	x	x	x	-	. A1	
				64 □ 32A	N20 .	x	-	x	-	x	. A1	
				50A	N33F .	x	x	x	-	x	. A1	
				88 □ 63A	N40 .	x	-	x	-	x	. A1	
90A	N61 .	x	-	x	-	x	. A1					
115A	N80 .	x	-	x	-	-	. A1					
132 □ 150A	N100 .	x	-	x	-	-	. A1					
250A	N200 .	x	-	x	-	-	. A1					
2-pole		60°	1	48 □ 20A	M10H .	x	x	x	x	x ¹⁾	. A2	
				32A	M20 .	x	x	x	x	-	. A2	
				64 □ 32A	N20 .	x	-	x	-	x	. A2	
				50A	N33F .	x	x	x	-	x	. A2	
				88 □ 63A	N40 .	x	-	x	-	x	. A2	
90A	N61 .	x	-	x	-	x	. A2					
115A	N80 .	x	-	x	-	-	. A2					
132 □ 150A	N100 .	x	-	x	-	-	. A2					
250A	N200 .	x	-	x	-	-	. A2					
3-pole		60°	2	48 □ 20A	M10H .	x	x	x	x	x ¹⁾	. A3	
				32A	M20 .	x	x	x	x	-	. A3	
				64 □ 32A	N20 .	x	-	x	-	x	. A3	
				50A	N33F .	x	x	x	-	x	. A3	
				88 □ 63A	N40 .	x	-	x	-	x	. A3	
90A	N61 .	x	-	x	-	x	. A3					
115A	N80 .	x	-	x	-	-	. A3					
132 □ 150A	N100 .	x	-	x	-	-	. A3					
250A	N200 .	x	-	x	-	-	. A3					
4-pole 4. pole early make		60°	2	48 □ 20A	M10H .	x	x	x	x	x ¹⁾	. A4	
				32A	M20 .	x	x	x	x	-	. A4	
				64 □ 32A	N20 .	x	-	x	-	x	. A4	
				50A	N33F .	x	-	x	-	x	. A4	
				88 □ 63A	N40 .	x	-	x	-	x	. A4	
90A	N61 .	x	-	x	-	x	. A4					
115A	N80 .	x	-	x	-	-	. A4					
132 □ 150A	N100 .	x	-	x	-	-	. A4					
250A	N200 .	x	-	x	-	-	. A4					
6-pole		60°	3	48 □ 20A	M10H .	x	x	x	x	x ¹⁾	. A6	
				32A	M20 .	x	x	x	x	-	. A6	
				64 □ 32A	N20 .	x	-	x	-	x	. A6	
				50A	N33F .	x	-	x	-	x	. A6	
				88 □ 63A	N40 .	x	-	x	-	x	. A6	
90A	N61 .	x	-	x	-	x	. A6					
115A	N80 .	x	-	x	-	-	. A6					
132 □ 150A	N100 .	x	-	x	-	-	. A6					
250A	N200 .	x	-	x	-	-	. A6					

Ordering example: AC21 250A panel mounting, On-Off-switch 6-pole, Escutcheon plate OFF - ON **N200 E A6+003**

1) Plastic enclosed switches are delivered with switch type M10.

Switching programs

Description	Wiring diagram	Switching angle	Number of cells ↓ Size ↓ AC21	Type	Design				Switch pro-	Escutcheon plate
					E.	Z.	V.	SMA.		
Changeover switches U										
1-pole		60°	1 48 □ 20A 32A	M10H . M20 .	x x x x	x ¹⁾			. U1 . U1	
			64 □ 32A 50A	N20 . N33F .	x - x - x			. U1 . U1		
			88 □ 63A 90A 115A	N40 . N61 . N80 .	x - x - x			. U1 . U1 . U1	+007 	
			132 □ 150A 250A	N100 . N200 .	x - x - -			. U1 . U1		
2-pole		60°	2 48 □ 20A 32A	M10H . M20 .	x x x x	x ¹⁾			. U2 . U2	
			64 □ 32A 50A	N20 . N33F .	x - x - x			. U2 . U2		
			88 □ 63A 90A 115A	N40 . N61 . N80 .	x - x - x			. U2 . U2 . U2	+007 	
			132 □ 150A 250A	N100 . N200 .	x - x - -			. U2 . U2		
3-pole		60°	3 48 □ 20A 32A	M10H . M20 .	x x x x	x ¹⁾			. U3 . U3	
			64 □ 32A 50A	N20 . N33F .	x - x - x			. U3 . U3		
			88 □ 63A 90A 115A	N40 . N61 . N80 .	x - x - x			. U3 . U3 . U3	+007 	
			132 □ 150A 250A	N100 . N200 .	x - x - -			. U3 . U3		
4-pole 4. pole early make		60°	4 48 □ 20A 32A	M10H . M20 .	x x x x	x ¹⁾			. U4 . U4	
			64 □ 32A 50A	N20 . N33F .	x - x - x			. U4 . U4		
			88 □ 63A 90A 115A	N40 . N61 . N80 .	x - x - x			. U4 . U4 . U4	+007 	
			132 □ 150A 250A	N100 . N200 .	x - x - -			. U4 . U4		
6-pole		60°	6 48 □ 20A 32A	M10H . M20 .	x x x -	x ¹⁾			. U6 . U6	
			64 □ 32A 50A	N20 . N33F .	x - x - x			. U6 . U6		
			88 □ 63A 90A 115A	N40 . N61 . N80 .	x - x - x			. U6 . U6 . U6	+007 	
			132 □ 150A 250A	N100 . N200 .	x - x - -			. U6 . U6		

Ordering example: AC21 250A panel mounting, changeover switch 6-pole, Escutcheon plate 1 - OFF - 2

N200 E U6+007

1) Plastic enclosed switches are delivered with switch type M10.

Switching programs

Description	Wiring diagram	Switching angle	Number of cells ↓ Size ↓ AC21	Type	Design					Switch pro-	Escutcheon plate	
					E.	Z.	V.	SMA.	P.			
Changeover switches without off W												
1-pole		60°	1	48 □ 20A	M10H .	x	x	x	x	x ¹⁾	. W1	
				32A	M20 .	x	x	x	x	-	. W1	
				64 □ 32A	N20 .	x	-	x	-	x	. W1	
				50A	N33F .	x	x	x	-	x	. W1	
				88 □ 63A	N40 .	x	-	x	-	x	. W1	
90A	N61 .	x	-	x	-	x	. W1					
115A	N80 .	x	-	x	-	-	. W1					
132 □ 150A	N100 .	x	-	x	-	-	. W1					
250A	N200 .	x	-	x	-	-	. W1					
2-pole		60°	2	48 □ 20A	M10H .	x	x	x	x	x ¹⁾	. W2	
				32A	M20 .	x	x	x	x	-	. W2	
				64 □ 32A	N20 .	x	-	x	-	x	. W2	
				50A	N33F .	x	x	x	-	x	. W2	
				88 □ 63A	N40 .	x	-	x	-	x	. W2	
90A	N61 .	x	-	x	-	x	. W2					
115A	N80 .	x	-	x	-	-	. W2					
132 □ 150A	N100 .	x	-	x	-	-	. W2					
250A	N200 .	x	-	x	-	-	. W2					
3-pole		60°	3	48 □ 20A	M10H .	x	x	x	x	x ¹⁾	. W3	
				32A	M20 .	x	x	x	x	-	. W3	
				64 □ 32A	N20 .	x	-	x	-	x	. W3	
				50A	N33F .	x	x	x	-	x	. W3	
				88 □ 63A	N40 .	x	-	x	-	x	. W3	
90A	N61 .	x	-	x	-	x	. W3					
115A	N80 .	x	-	x	-	-	. W3					
132 □ 150A	N100 .	x	-	x	-	-	. W3					
250A	N200 .	x	-	x	-	-	. W3					
4-pole 4. pole early make		60°	4	48 □ 20A	M10H .	x	x	x	x	x ¹⁾	. W4	
				32A	M20 .	x	x	x	x	-	. W4	
				64 □ 32A	N20 .	x	-	x	-	x	. W4	
				50A	N33F .	x	-	x	-	x	. W4	
				88 □ 63A	N40 .	x	-	x	-	x	. W4	
90A	N61 .	x	-	x	-	x	. W4					
115A	N80 .	x	-	x	-	-	. W4					
132 □ 150A	N100 .	x	-	x	-	-	. W4					
250A	N200 .	x	-	x	-	-	. W4					
6-pole		60°	6	48 □ 20A	M10H .	x	x	x	-	x ¹⁾	. W6	
				32A	M20 .	x	x	x	-	-	. W6	
				64 □ 32A	N20 .	x	-	x	-	x	. W6	
				50A	N33F .	x	-	x	-	x	. W6	
				88 □ 63A	N40 .	x	-	x	-	x	. W6	
90A	N61 .	x	-	x	-	x	. W6					
115A	N80 .	x	-	x	-	-	. W6					
132 □ 150A	N100 .	x	-	x	-	-	. W6					
250A	N200 .	x	-	x	-	-	. W6					

Ordering example: AC21 250A panel mounting, changeover switch without off 6-pole, **N200 E W6**

1) Plastic enclosed switches are delivered with switch type M10.

Switching programs

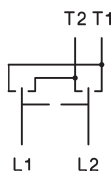
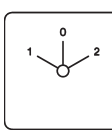
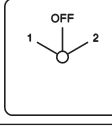
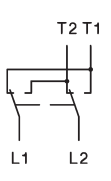
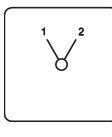
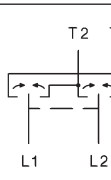
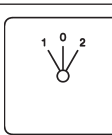
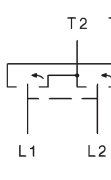
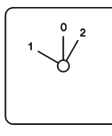
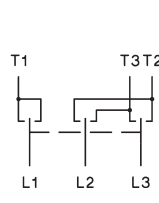
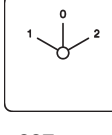
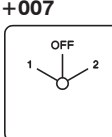
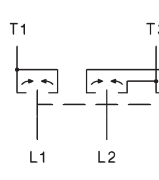
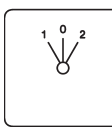
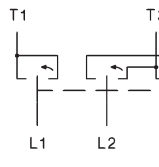
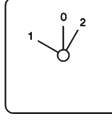
Description	Wiring diagram	Switching angle	Number of cells ↓ Size ↓ AC21	Type	Design E. Z. V. SMA. P. ↓ ↓ ↓ ↓ ↓	Switch pro-	Escutcheon plate	
Reversing switches WU								
2-pole		60°	2	48 □ 20A	M10H . x x x x x ¹⁾	. WU2		
				32A	M20 . x x x x -	. WU2		
				64 □ 32A	N20 . x - x - x	. WU2		
				50A	N33F . x x x - x	. WU2		
				88 □ 63A	N40 . x - x - x	. WU2		
90A	N61 . x - x - x	. WU2						
115A	N80 . x - x - -	. WU2						
132 □ 150A	N100 . x - x - -	. WU2	+007 					
250A	N200 . x - x - -	. WU2						
2-pole without off cross switch		60°		2	48 □ 20A	M10H . x x x x x ¹⁾	. WK2	
					32A	M20 . x x x x -	. WK2	
					64 □ 32A	N20 . x - x - x	. WK2	
			50A		N33F . x x x - x	. WK2		
			88 □ 63A		N40 . x x - - x	. WK2		
90A	N61 . x - x - x	. WK2						
115A	N80 . x - x - -	. WK2						
132 □ 150A	N100 . x - x - -	. WK2						
250A	N200 . x - x - -	. WK2						
2-pole with spring return from both sides to off		30°	2	48 □ 20A	M10H . x x x x x ¹⁾	. WU2R2		
				32A	M20 . x x x x -	. WU2R2		
				64 □ 32A	N20 . x - x - x	. WU2R2		
50A	N33F . x x x - x	. WU2R2						
88 □ 63A	N40 . x - x - x	. WU2R2						
2-pole position 1 latched position 2 with spring return to off		60°+30°	2	48 □ 20A	M10H . x x x x x ¹⁾	. WU2R1		
				32A	M20 . x x x x -	. WU2R1		
				64 □ 32A	N20 . x - x - x	. WU2R1		
50A	N33F . x x x - x	. WU2R1						
88 □ 63A	N40 . x - x - x	. WU2R1						
3-pole		60°	3	48 □ 20A	M10H . x x x x x ¹⁾	. WU3		
				32A	M20 . x x x x -	. WU3		
				64 □ 32A	N20 . x - x - x	. WU3		
				50A	N33F . x x x - x	. WU3		
				88 □ 63A	N40 . x - x - x	. WU3		
90A	N60 . x - x - x	. WU3						
115A	N80 . x - x - -	. WU3						
132 □ 150A	N100 . x - x - -	. WU3	+007 					
250A	N200 . x - x - -	. WU3						
3-pole with spring return from both sides to off		30°		3	48 □ 20A	M10H . x x x x x ¹⁾	. WU3R2	
					32A	M20 . x x x x -	. WU3R2	
					64 □ 32A	N20 . x - x - x	. WU3R2	
50A	N33F . x x x - x	. WU3R2						
88 □ 63A	N40 . x - x x	. WU3R2						
3-pole position 1 latched position 2 with spring return to off		60°+30°	3	48 □ 20A	M10H . x x x x x ¹⁾	. WU3R1		
				32A	M20 . x x x x -	. WU3R1		
				64 □ 32A	N20 . x - x - x	. WU3R1		
50A	N33F . x - x - x	. WU3R1						
88 □ 63A	N40 . x - x - x	. WU3R1						

Ordering example: AC21 63A base mounting, reversing switch 3-pole, position 2 with spring to off N40 V WU3R1

1) Plastic enclosed switches are delivered with switch type M10.

Switching programs

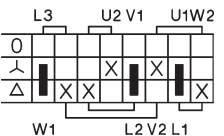
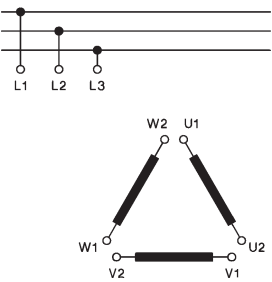
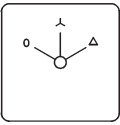
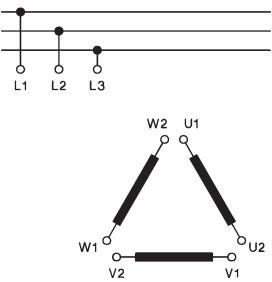
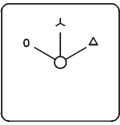
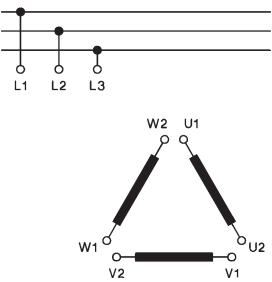
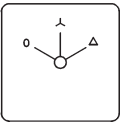
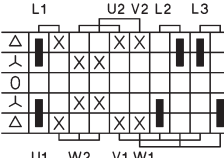
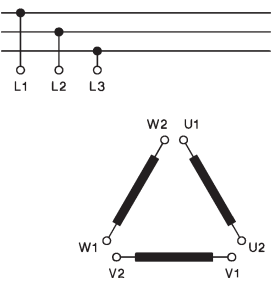
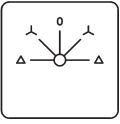
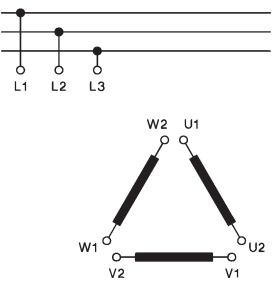
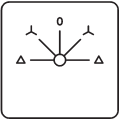
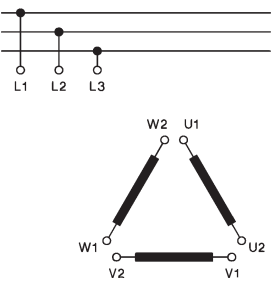
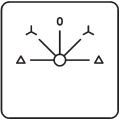
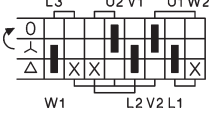
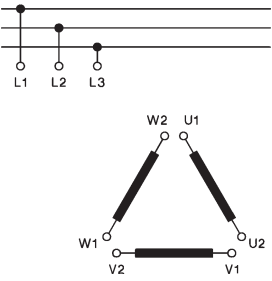
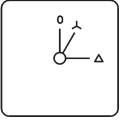
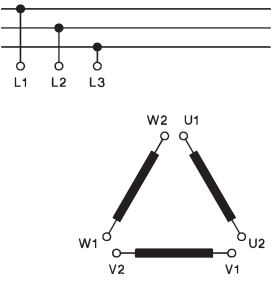
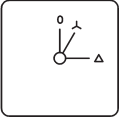
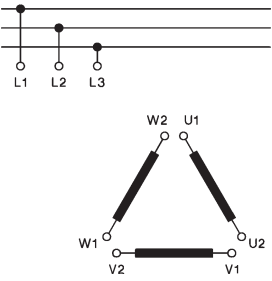
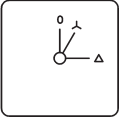
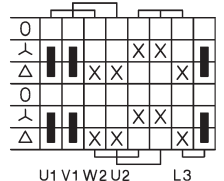
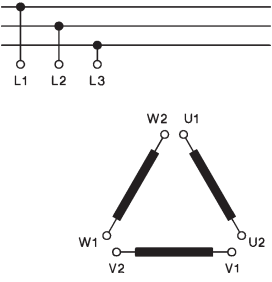
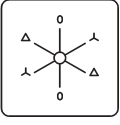
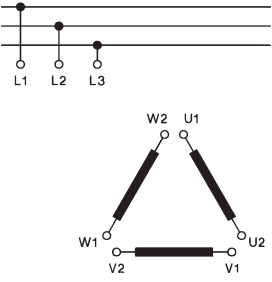
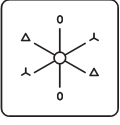
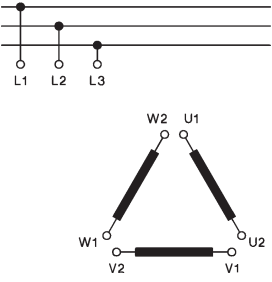
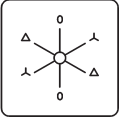
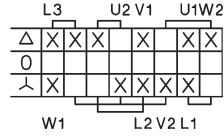
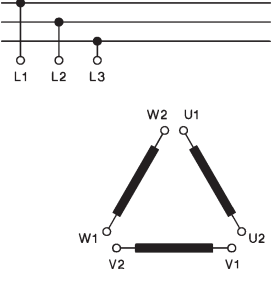
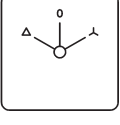
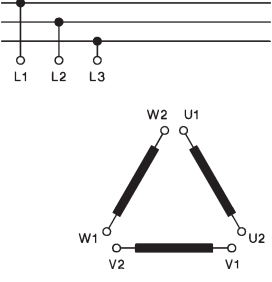
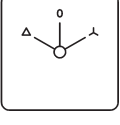
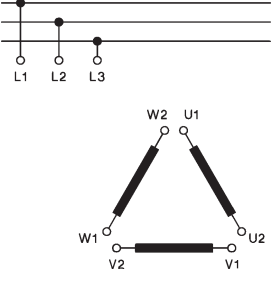
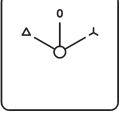
Description	Wiring diagram	Switching angle	Number of cells ↓ Size ↓ AC21	Type	Design				Switch pro-	Escutcheon plate			
					E.	Z.	V.	SMA.			P.		
Star-Delta switches SD													
1 rotary direction 		60°	4	48 □ 20A	M10H	x	x	x	x	x ¹⁾	.SD		
				32A	M20	x	x	x	x	-	.SD		
				64 □ 32A	N20	x	-	x	-	x	.SD		
				50A	N33F	x	-	x	-	x	.SD		
88 □ 63A		60°	4	90A	N40	x	-	x	-	x	.SD		
				115A	N61	x	-	x	-	x	.SD		
					N80	x	-	x	-	-	.SD		
132 □ 150A		60°	4	250A	N100	x	-	x	-	-	.SD		
					N200	x	-	x	-	-	.SD		
both rotary directions 		45°	5	48 □ 20A	M10H	x	x	x	x	x ¹⁾	.SDR		
				32A	M20	x	x	x	x	-	.SDR		
				64 □ 32A	N20	x	-	x	-	x	.SDR		
				50A	N33F	x	-	x	-	x	.SDR		
88 □ 63A		45°	5	90A	N40	x	-	x	-	x	.SDR		
				115A	N61	x	-	x	-	x	.SDR		
					N80	x	-	x	-	-	.SDR		
132 □ 150A		45°	5	250A	N100	x	-	x	-	-	.SDR		
					N200	x	-	x	-	-	.SDR		
1 rotary direction spring return from Y to off 		60°	4	48 □ 20A	M10H	x	x	x	x	x ¹⁾	.SRD		
				32A	M20	x	x	x	x	-	.SRD		
				64 □ 32A	N20	x	-	x	-	x	.SRD		
				50A	N33F	x	-	x	-	x	.SRD		
88 □ 63A		60°	4	90A	N40	x	-	x	-	x	.SRD		
				115A	N60	x	-	x	-	x	.SRD		
					N80	x	-	x	-	-	.SRD		
132 □ 150A		60°	4	250A	N100	x	-	x	-	-	.SRD		
					N200	x	-	x	-	-	.SRD		
1 rotary direction with clockwise operation and backswitch interlock 		60°	5	48 □ 20A	M10H	x	x	x	x	x ¹⁾	.SDRU		
				32A	M20	x	x	x	x	-	.SDRU		
				64 □ 32A	N20	x	-	x	-	x	.SDRU		
				50A	N33F	x	-	x	-	x	.SDRU		
88 □ 63A		60°	5	90A	N40	x	-	x	-	x	.SDRU		
				115A	N60	x	-	x	-	x	.SDRU		
					N80	x	-	x	-	-	.SDRU		
132 □ 150A		60°	5	250A	N100	x	-	x	-	-	.SDRU		
					N200	x	-	x	-	-	.SDRU		
Star-Delta selector switch 		60°	4	48 □ 20A	M10H	x	x	x	x	x ¹⁾	.SDU		
				32A	M20	x	x	x	x	-	.SDU		
				64 □ 32A	N20	x	-	x	-	x	.SDU		
				50A	N33F	x	-	x	-	x	.SDU		
88 □ 63A		60°	4	90A	N40	x	-	x	-	x	.SDU		
				115A	N60	x	-	x	-	x	.SDU		
					N80	x	-	x	-	-	.SDU		
132 □ 150A		60°	4	250A	N100	x	-	x	-	-	.SDU		
					N200	x	-	x	-	-	.SDU		

Ordering example: AC21 32A plastic enclosed, star-delta selector switch

N20 P SDU

1) Plastic enclosed switches are delivered with switch type M10.

Switching programs

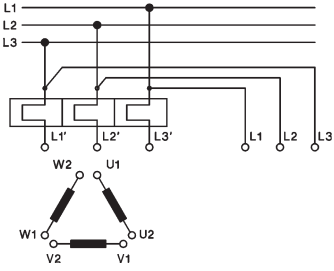
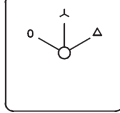
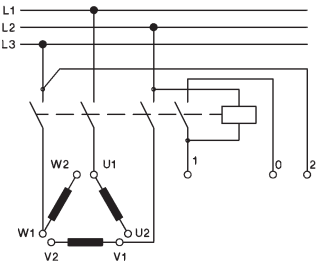
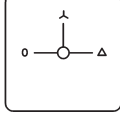
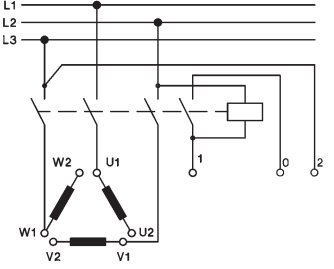
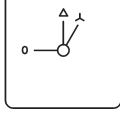
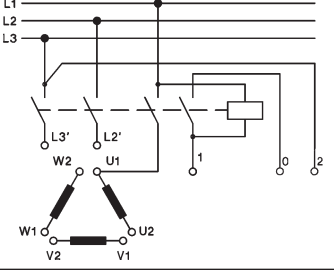
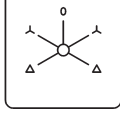
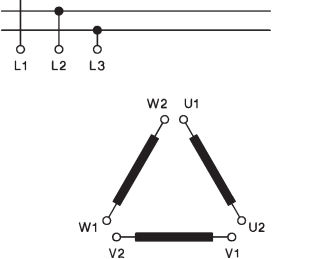
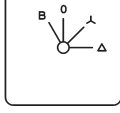
Description	Wiring diagram	Switching angle	Number of cells ↓ Size ↓ AC21	Type	Design				Switch pro-	Escutcheon plate		
					E.	Z.	V.	SMA. P.				
with double outfeed phases for use with manual motor starter 		60°	4	48 □ 20A 32A	M10H .	x	x	x	x	x ¹⁾ -	. SDMO	
					M20 .	x	x	x	x	- -	. SDMO	
				64 □ 32A 50A	N20 .	x	-	x	-	x	x	. SDMO
					N33F .	x	-	x	-	x	-	. SDMO
				88 □ 63A 90A 115A	N40 .	x	-	x	-	x	-	. SDMO
		N61 .	x	-	x	-	x	-	. SDMO			
		N80 .	x	-	x	-	-	-	. SDMO			
	132 □ 150A 250A	N100 .	x	-	x	-	-	-	. SDMO			
		N200 .	x	-	x	-	-	-	. SDMO			
with auxiliary contacts for contactor control, without main contacts, automatic zero setting in event of mains break-down 		90°	4	48 □ 20A 32A	M10H .	x	x	x	x	x ¹⁾ -	. SDJ1	
					M20 .	x	x	x	x	- -	. SDJ1	
				64 □ 32A 50A	N20 .	x	-	x	-	x	x	. SDJ1
					N33F .	x	-	x	-	x	-	. SDJ1
				88 □ 63A 90A 115A	N40 .	x	-	x	-	x	-	. SDJ1
		N61 .	x	-	x	-	x	-	. SDJ1			
		N80 .	x	-	x	-	-	-	. SDJ1			
	132 □ 150A 250A	N100 .	x	-	x	-	-	-	. SDJ1			
		N200 .	x	-	x	-	-	-	. SDJ1			
with auxiliary contacts for contactor control, without main contacts, automatic zero setting in event of mains break-down, spring return to 		90°+30°	4	48 □ 20A 32A	M10H .	x	x	x	x	x ¹⁾ -	. SDJ2	
					M20 .	x	x	x	x	- -	. SDJ2	
				64 □ 32A 50A	N20 .	x	-	x	-	x	x	. SDJ2
					N33F .	x	-	x	-	x	-	. SDJ2
				88 □ 63A 90A 115A	N40 .	x	-	x	-	x	-	. SDJ2
		N61 .	x	-	x	-	x	-	. SDJ2			
		N80 .	x	-	x	-	-	-	. SDJ2			
	132 □ 150A 250A	N100 .	x	-	x	-	-	-	. SDJ2			
		N200 .	x	-	x	-	-	-	. SDJ2			
as type SDJ1 but for both rotary directions 		60°	7	48 □ 20A 32A	M10H .	x	x	x	-	-	. SDRJ1	
					M20 .	x	x	x	-	-	. SDRJ1	
				64 □ 32A 50A	N20 .	x	-	x	-	x	x	. SDRJ1
					N33F .	x	-	x	-	-	-	. SDRJ1
				88 □ 63A 90A 115A	N40 .	x	-	x	-	x	-	. SDRJ1
		N61 .	x	-	x	-	-	-	. SDRJ1			
		N80 .	x	-	x	-	-	-	. SDRJ1			
	132 □ 150A 250A	N100 .	x	-	x	-	-	-	. SDRJ1			
		N200 .	x	-	x	-	-	-	. SDRJ1			
with brake position (counter current braking) brake position is a momentary operation 		45°+30°	5	48 □ 20A 32A	M10H .	x	x	x	x	x ¹⁾ -	. SDB	
					M20 .	x	x	x	x	- -	. SDB	
				64 □ 32A 50A	N20 .	x	-	x	-	x	x	. SDB
					N33F .	x	-	x	-	x	-	. SDB
				88 □ 63A 90A 115A	N40 .	x	-	x	-	x	-	. SDB
		N61 .	x	-	x	-	x	-	. SDB			
		N80 .	x	-	x	-	-	-	. SDB			
	132 □ 150A 250A	N100 .	x	-	x	-	-	-	. SDB			
		N200 .	x	-	x	-	-	-	. SDB			

Ordering example: AC21 250A panel mounting star-delta switch with brake position

N200 E SDB

1) Plastic enclosed switches are delivered with switch type M10.

Switching programs

Description	Wiring diagram	Switching angle	Number of cells ↓ Size ↓ AC21	Type	Design				Switch pro-	Escutcheon plate			
					E.	Z.	V.	SMA. P.					
for starting up single-phase motors with split-phase, spring return from START to Off		30°+60°	2	48 □ 20A 32A	M10H . x x x x x ¹⁾ - . HP1 M20 . x x x x - - . HP1	x	x	x	x	x ¹⁾	-		
			64 □ 32A 50A	N20 . x - x - x x . HP1 N33F . x - x - x - . HP1	x	-	x	-	x	x	.		HP1
			88 □ 63A	N40 . x - x - x - . HP1	x	-	x	-	x	-	.		HP1
for starting up single-phase motors with split-phase, spring return from START to 1		90°+30°	2	48 □ 20A 32A	M10H . x x x x x ¹⁾ - . HP2 M20 . x x x x - - . HP2	x	x	x	x	x ¹⁾	-		
			64 □ 32A 50A	N20 . x - x - x x . HP2 N33F . x - x - x - . HP2	x	-	x	-	x	x	.		HP2
			88 □ 63A	N40 . x - x - x - . HP2	x	-	x	-	x	-	.		HP2
for starting up single-phase motors with split-phase, both rotary directions		60°+30°	3	48 □ 20A 32A	M10H . x x x x x ¹⁾ - . HPR1 M20 . x x x x - - . HPR1	x	x	x	x	x ¹⁾	-		
			64 □ 32A 50A	N20 . x - x - x x . HPR1 N33F . x - x - x - . HPR1	x	-	x	-	x	x	.		HPR1
			88 □ 63A	N40 . x - x - x - . HPR1	x	-	x	-	x	-	.		HPR1
as type HPR1 with starting and phase-shifting capacitor		60°+30°	4	48 □ 20A 32A	M10H . x x x x x ¹⁾ - . HPR2 M20 . x x x x - - . HPR2	x	x	x	x	x ¹⁾	-		
			64 □ 32A 50A	N20 . x - x - x x . HPR2 N33F . x - x - x - . HPR2	x	-	x	-	x	x	.		HPR2
			88 □ 63A	N40 . x - x - x - . HPR2	x	-	x	-	x	-	.		HPR2

Ordering example: AC21 63A panel mounting, split phase switch, both rotary directions **N40 E HPR1**

1) Plastic enclosed switches are delivered with switch type M10.

Switching programs

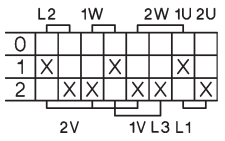
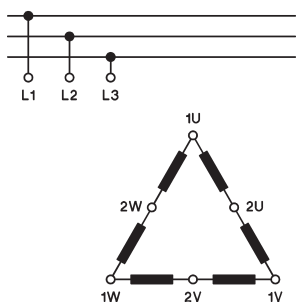
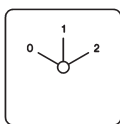
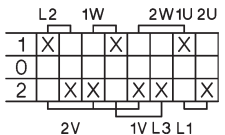
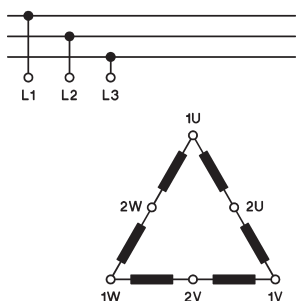
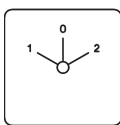
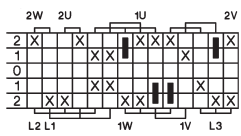
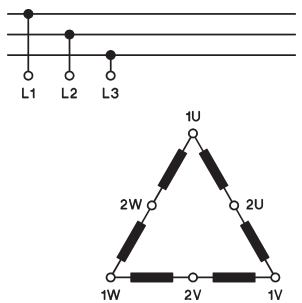
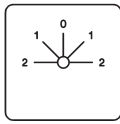
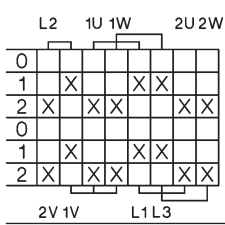
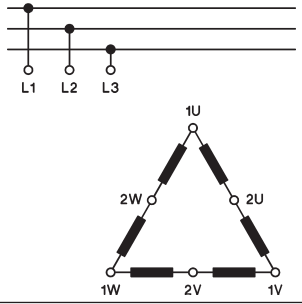
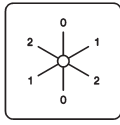
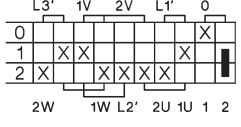
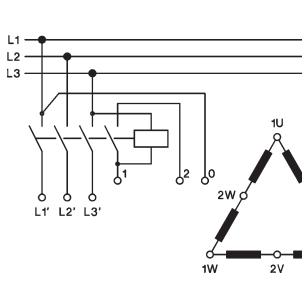
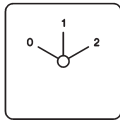
Description	Wiring diagram	Switching angle	Number of cells		Type	Design				Switch pro-	Escutcheon plate			
			↓ Size	↓ AC21		E.	Z.	V.	SMA.			P.		
1 Dahlander winding 1 rotary direction 		60°	4	48 □ 20A 32A	M10H . x x x x x ¹⁾ - . P61 M20 . x x x x - - . P61	x	x	x	x	x ¹⁾	-	. P61		
			64 □ 32A 50A	N20 . x - x - x x . P61 N33F . x - x - x - . P61	x	-	x	-	x	x	-	-		. P61
			88 □ 63A 90A 115A	N40 . x - x - x - . P61 N61 . x - x - x - . P61 N80 . x - x - - - . P61	x	-	x	-	x	-	-	-		. P61
			132 □ 150A 250A	N100 . x - x - - - . P61 N200 . x - x - - - . P61	x	-	x	-	-	-	-	-		. P61
1 Dahlander winding 1 rotary direction 		60°	4	48 □ 20A 32A	M10H . x x x x x ¹⁾ - . P62 M20 . x x x x - - . P62	x	x	x	x	x ¹⁾	-	. P62		
			64 □ 32A 50A	N20 . x - x - x x . P62 N33F . x - x - x - . P62	x	-	x	-	x	x	-	-		. P62
			88 □ 63A 90A 115A	N40 . x - x - x - . P62 N61 . x - x - x - . P62 N80 . x - x - - - . P62	x	-	x	-	x	-	-	-		. P62
			132 □ 150A 250A	N100 . x - x - - - . P62 N200 . x - x - - - . P62	x	-	x	-	-	-	-	-		. P62
1 Dahlander winding both rotary directions 		60°	7	48 □ 20A 32A	M10H . x x x - - - . P61R M20 . x x x - - - . P61R	x	x	x	-	-	-	. P61R		
			64 □ 32A 50A	N20 . x - x - x - . P61R N33F . x - x - - - . P61R	x	-	x	-	-	-	-	-		. P61R
			88 □ 63A 90A 115A	N40 . x - x - x - . P61R N61 . x - x - - - . P61R N80 . x - x - - - . P61R	x	-	x	-	-	-	-	-		. P61R
			132 □ 150A 250A	N100 . x - x - - - . P61R N200 . x - x - - - . P61R	x	-	x	-	-	-	-	-		. P61R
1 Dahlander winding 1 rotary direction, clockwise operation 		60°	5	48 □ 20A 32A	M10H . x x x x x ¹⁾ - . P61RU M20 . x x x x - - . P61RU	x	x	x	x	x ¹⁾	-	. P61RU		
			64 □ 32A 50A	N20 . x - x - x x . P61RU N33F . x - x - x - . P61RU	x	-	x	-	x	x	-	-		. P61RU
			88 □ 63A 90A 115A	N40 . x - x - x - . P61RU N61 . x - x - x - . P61RU N80 . x - x - - - . P61RU	x	-	x	-	x	-	-	-		. P61RU
			132 □ 150A 250A	N100 . x - x - - - . P61RU N200 . x - x - - - . P61RU	x	-	x	-	-	-	-	-		. P61RU
1 Dahlander winding 1 rotary direction, with auxiliary contacts for contactor control 		60°	5	48 □ 20A 32A	M10H . x x x x x ¹⁾ - . P61J M20 . x x x x - - . P61J	x	x	x	x	x ¹⁾	-	. P61J		
			64 □ 32A 50A	N20 . x - x - x x . P61J N33F . x - x - x - . P61J	x	-	x	-	x	x	-	-		. P61J
			88 □ 63A 90A 115A	N40 . x - x - x - . P61J N61 . x - x - x - . P61J N80 . x - x - - - . P61J	x	-	x	-	x	-	-	-		. P61J
			132 □ 150A 250A	N100 . x - x - - - . P61J N200 . x - x - - - . P61J	x	-	x	-	-	-	-	-		. P61J

Ordering example: AC21 32A cast enclosed, multi speed switch, 1 Dahlander winding, 1 rotary direction

N20 G P61

1) Plastic enclosed switches are delivered with switch type M10.

Switching programs

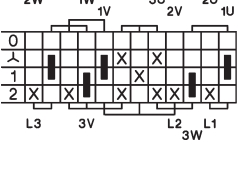
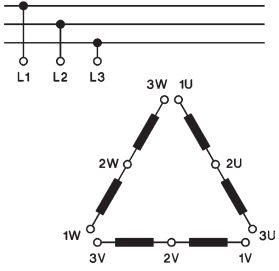
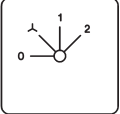
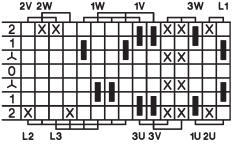
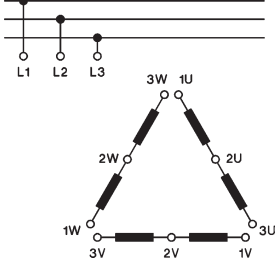
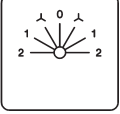
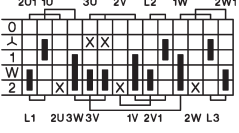
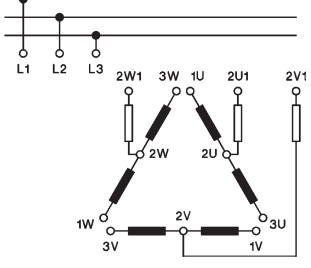
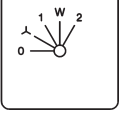
Description	Wiring diagram	Switching angle	Number of cells ↓ Size ↓ AC21	Type	Design				Switch pro-	Escutcheon plate			
					E.	Z.	V.	SMA. P.					
open Dahlander winding 1 rotary direction low speed with star-delta-start 		45°	6	48 □ 20A	M10H .	x	x	x	-	x ¹⁾ -	. P91		
				32A	M20 .	x	x	x	-	-	-		. P91
				64 □ 32A	N20 .	x	-	x	-	x	x		. P91
				50A	N33F .	x	-	x	-	x	-		. P91
				88 □ 63A	N40 .	x	-	x	-	x	-		. P91
open Dahlander winding both rotary directions low speed with star-delta-start 		30°	8	48 □ 20A	M10H .	x	x	x	-	-	-	. P91R	
				32A	M20 .	x	x	x	-	-	-	. P91R	
				64 □ 32A	N20 .	x	-	x	-	x	-	. P91R	
				50A	N33F .	x	-	x	-	x	-	. P91R	
				88 □ 63A	N40 .	x	-	x	-	x	-	. P91R	
open Dahlander winding 1 rotary direction, low speed with star-delta-start, with additional start position (starting resistor) 		30°	7	48 □ 20A	M10H .	x	x	x	-	-	-	. P91W	
				32A	M20 .	x	x	x	-	-	-	. P91W	
				64 □ 32A	N20 .	x	-	x	-	x	-	. P91W	
				50A	N33F .	x	-	x	-	x	-	. P91W	
				88 □ 63A	N40 .	x	-	x	-	x	-	. P91W	
90A N61 . x - x - - - - . P91W	115A N80 . x - x - - - - . P91W	132 □ 150A N100 . x - x - - - - . P91W	250A N200 . x - x - - - - . P91W										

Ordering example: AC21 250A panel mounting, multi speed switch, 1 rotary direction, low speed with star-delta-start

N200 E P91

1) Plastic enclosed switches are delivered with switch type M10.

Switching programs

Description	Wiring diagram	Switching angle	Number of cells		Type	Design				Switch pro-	Escutcheon plate
			↓ Size	↓ AC21		E.	Z.	V.	SMA.		
2 separate windings 1 rotary direction		60°	3	48 □ 20A 32A	M10H . x x x x x ¹⁾ - . P63 M20 . x x x x - - . P63						
				64 □ 32A 50A	N20 . x - x - x x . P63 N33F . x - x - x - . P63						
				88 □ 63A 90A 115A	N40 . x - x - x - . P63 N61 . x - x - x - . P63 N80 . x - x - - - . P63						
				132 □ 150A 250A	N100 . x - x - - - . P63 N200 . x - x - - - . P63						
2 separate windings 1 rotary direction		60°	3	48 □ 20A 32A	M10H . x x x x x ¹⁾ - . P64 M20 . x x x x - - . P64						
				64 □ 32A 50A	N20 . x - x - x x . P64 N33F . x - x - x - . P64						
				88 □ 63A 90A 115A	N40 . x - x - x - . P64 N61 . x - x - x - . P64 N80 . x - x - - - . P64						
				132 □ 150A 250A	N100 . x - x - - - . P64 N200 . x - x - - - . P64						
2 separate windings both rotary directions		60°	5	48 □ 20A 32A	M10H . x x x x x ¹⁾ - . P66 M20 . x x x x - - . P66						
				64 □ 32A 50A	N20 . x - x - x x . P66 N33F . x - x - x - . P66						
				88 □ 63A 90A 115A	N40 . x - x - x - . P66 N61 . x - x - x - . P66 N80 . x - x - - - . P66						
				132 □ 150A 250A	N100 . x - x - - - . P66 N200 . x - x - - - . P66						
2 separate windings 1 opened 1 rotary direction		60°	4	48 □ 20A 32A	M10H . x x x x x ¹⁾ - . P71 M20 . x x x x - - . P71						
				64 □ 32A 50A	N20 . x - x - x x . P71 N33F . x - x - x - . P71						
				88 □ 63A 90A 115A	N40 . x - x - x - . P71 N61 . x - x - x - . P71 N80 . x - x - - - . P71						
				132 □ 150A 250A	N100 . x - x - - - . P71 N200 . x - x - - - . P71						
2 separate windings 1 rotary direction low speed with star-delta-start		45°	6	48 □ 20A 32A	M10H . x x x - x ¹⁾ - . P96 M20 . x x x - - - . P96						
				64 □ 32A 50A	N20 . x - x - x x . P96 N33F . x - x - x - . P96						
				88 □ 63A 90A 115A	N40 . x - x - x - . P96 N61 . x - x - x - . P96 N80 . x - x - - - . P96						
				132 □ 150A 250A	N100 . x - x - - - . P96 N200 . x - x - - - . P96						

Ordering example: AC21 250A panel mounting, multi speed switch, 2 separate windings, low speed with star-delta-start **N200 E P96**

1) Plastic enclosed switches are delivered with switch type M10.

Switching programs

Description	Wiring diagram	Switching angle	Number of cells ↓ Size ↓ AC21	Type	Design				Switch pro-	Escutcheon plate					
					E.	Z.	V.	SMA. P.							
Multi speed switches P															
2 separate windings 1 rotary direction both speeds with star-delta-start		45°	8	48 □	20A 32A	M10H .	x	x	x	-	-	-	. P122		
				64 □	32A 50A	N20 .	x	-	x	-	x	-	-		. P122
				88 □	63A 90A 115A	N40 .	x	-	x	-	x	-	-		. P122
				132 □	150A 250A	N100 .	x	-	x	-	-	-	-		. P122
1 Dahlander winding A 1 normal winding B 3 speeds 1 rotary direction 0-AΔ-BΔ or Δ-AΔ		45°	6	48 □	20A 32A	M10H .	x	x	x	-	x ¹⁾	-	. P93		
				64 □	32A 50A	N20 .	x	-	x	-	x	x	-		. P93
				88 □	63A 90A 115A	N40 .	x	-	x	-	x	-	-		. P93
				132 □	150A 250A	N100 .	x	-	x	-	-	-	-		. P93
1 Dahlander winding A 1 normal winding B 3 speeds 1 rotary direction 0-BΔ or Δ-AΔ-AΔ		45°	6	48 □	20A 32A	M10H .	x	x	x	-	x ¹⁾	-	. P94		
				64 □	32A 50A	N20 .	x	-	x	-	x	-	-		. P94
				88 □	63A 90A 115A	N40 .	x	-	x	-	x	-	-		. P94
				132 □	150A 250A	N100 .	x	-	x	-	-	-	-		. P94
1 Dahlander winding A 1 normal winding B 3 speeds 1 rotary direction 0-AΔ-AΔ-BΔ or Δ		45°	6	48 □	20A 32A	M10H .	x	x	x	-	x ¹⁾	-	. P95		
				64 □	32A 50A	N20 .	x	-	x	-	x	x	-		. P95
				88 □	63A 90A 115A	N40 .	x	-	x	-	x	-	-		. P95
				132 □	150A 250A	N100 .	x	-	x	-	-	-	-		. P95
1 Dahlander winding A 1 normal winding B 3 speeds both rotary directions		45°	9	48 □	20A 32A	M10H .	x	x	x	-	-	-	. P93R		
				64 □	32A 50A	N20 .	x	-	x	-	-	-	-		. P93R
				88 □	63A 90A 115A	N40 .	x	-	x	-	-	-	-		. P93R
				132 □	150A 250A	N100 .	x	-	x	-	-	-	-		. P93R

Ordering example: AC21 250A panel mounting, multi speed switch, 1 Dahlander winding A,
1 normal winding B, 3 speeds, both rotary directions **N200 E P93R**

1) Plastic enclosed switches are delivered with switch type M10.

Switching programs

Description	Wiring diagram	Switching angle	Number of cells		Type	Design				Switch pro-	Escutcheon plate				
			↓ Size	↓ AC21		E.	Z.	V.	SMA.			P.			
1 Dahlander winding A 1 normal winding B 3 speeds both rotary directions		45°	9	48 □ 20A	M10H .	x	x	x	-	-	-	. P94R			
							M20 .	x	x	x	-	-		-	. P94R
				64 □ 32A	N20 .	x	-	x	-	-	-	-		-	. P94R
							N33F .	x	-	x	-	-		-	. P94R
				88 □ 63A	N40 .	x	-	x	-	-	-	-		-	. P94R
					N61 .	x	-	x	-	-	-	. P94R			
					N80 .	x	-	x	-	-	-	. P94R			
			132 □ 150A		N100 .	x	-	x	-	-	-	. P94R			
					N200 .	x	-	x	-	-	-	. P94R			
1 Dahlander winding A 1 normal winding B 3 speeds both rotary directions		45°	8	48 □ 20A	M10H .	x	x	x	-	-	-	. P95R			
							M20 .	x	x	x	-	-		-	. P95R
				64 □ 32A	N20 .	x	-	x	-	-	x	-		-	. P95R
							N33F .	x	-	x	-	-		-	. P95R
				88 □ 63A	N40 .	x	-	x	-	-	x	-		-	. P95R
					N61 .	x	-	x	-	-	-	. P95R			
					N80 .	x	-	x	-	-	-	. P95R			
			132 □ 150A		N100 .	x	-	x	-	-	-	. P95R			
					N200 .	x	-	x	-	-	-	. P95R			
2 Dahlander windings 4 speeds 1 rotary direction 0-AΔ-BΔ-AΔ-BΔ		30°	8	48 □ 20A	M10H .	x	x	x	-	-	-	. P124			
							M20 .	x	x	x	-	-		-	. P124
				64 □ 32A	N20 .	x	-	x	-	-	x	-		-	. P124
							N33F .	x	-	x	-	-		-	. P124
				88 □ 63A	N40 .	x	-	x	-	-	x	-		-	. P124
					N61 .	x	-	x	-	-	-	. P124			
					N80 .	x	-	x	-	-	-	. P124			
			132 □ 150A		N100 .	x	-	x	-	-	-	. P124			
					N200 .	x	-	x	-	-	-	. P124			
2 Dahlander windings 4 speeds both rotary directions		30°	12	48 □ 20A	M10H .	x	x	x	-	-	-	. P124R			
							M20 .	x	x	x	-	-		-	. P124R
				64 □ 32A	N20 .	x	-	x	-	-	-	-		-	. P124R
							N33F .	x	-	x	-	-		-	. P124R
				88 □ 63A	N40 .	x	-	x	-	-	-	-		-	. P124R
					N61 .	x	-	x	-	-	-	. P124R			
					N80 .	x	-	x	-	-	-	. P124R			
			132 □ 150A		N100 .	x	-	x	-	-	-	. P124R			
					N200 .	x	-	x	-	-	-	. P124R			

Ordering example: AC21 250A Base mounting, multi speed switch, 2 Dahlander windings, 4 speeds, 1 rotary direction

N200 V P124

Switching programs

Description	Wiring diagram	Switching angle	Number of cells ↓ Size ↓ AC21	Type	Design				Switch pro-	Escutcheon plate
					E.	Z.	V.	SMA.		
Changeover switches with spring return to off UR										
1-pole		30°	1	48 □ 20A 32A	M10H . x x x x x ¹⁾ - . UR1 M20 . x x x x - - . UR1					
				64 □ 32A 50A	N20 . x - x - x x . UR1 N33F . x - x - x - . UR1					
				88 □ 63A	N40 . x - x - x - . UR1				+264 	
2-pole		30°	2	48 □ 20A 32A	M10H . x x x x x ¹⁾ - . UR2 M20 . x x x x - - . UR2					
				64 □ 32A 50A	N20 . x - x - x x . UR2 N33F . x - x - x - . UR2					
				88 □ 63A	N40 . x - x - x - . UR2				+264 	
3-pole		30°	3	48 □ 20A 32A	M10H . x x x x x ¹⁾ - . UR3 M20 . x x x x - - . UR3					
				64 □ 32A 50A	N20 . x - x - x x . UR3 N33F . x - x - x - . UR3					
				88 □ 63A	N40 . x - x - x - . UR3				+264 	
Changeover switches with 1 latched and 1 momentary position UK										
1-pole position 1 latched position 2 with spring return		60°+30°	1	48 □ 20A 32A	M10H . x x x x x ¹⁾ - . UK1 M20 . x x x x - - . UK1					
				64 □ 32A 50A	N20 . x - x - x x . UK1 N33F . x - x - x - . UK1					
				88 □ 63A	N40 . x - x - x - . UK1					
2-pole position 1 latched position 2 with spring return		60°+30°	2	48 □ 20A 32A	M10H . x x x x x ¹⁾ - . UK2 M20 . x x x x - - . UK2					
				64 □ 32A 50A	N20 . x - x - x x . UK2 N33F . x - x - x - . UK2					
				88 □ 63A	N40 . x - x - x - . UK2					
3-pole position 1 latched position 2 with spring return		60°+30°	3	48 □ 20A 32A	M10H . x x x x x ¹⁾ - . UK3 M20 . x x x x - - . UK3					
				64 □ 32A 50A	N20 . x - x - x x . UK3 N33F . x - x - x - . UK3					
				88 □ 63A	N40 . x - x - x - . UK3					

Ordering example: AC21 63A panel mounting, changeover switch, position 1 latched, position 2 with spring return, 3-pole: **N40 E UK3**

1) Plastic enclosed switches are delivered with switch type M10.

Switching programs

Description	Wiring diagram	Switching angle	Number of cells ↓ Size ↓ AC21	Type	Design				Switch pro-	Escutcheon plate
					E.	Z.	V.	SMA. P.		
Double throw switches with spring return to off WR										
1-pole		30°	1	48 □ 20A 32A	M10H . x x x x x ¹⁾ - . W1R M20 . x x x x - - . W1R					
			64 □ 32A 50A	N20 . x - x - x x . W1R N33F . x - x - x - . W1R						
			88 □ 63A	N40 . x - x - x - . W1R						
2-pole		30°	2	48 □ 20A 32A	M10H . x x x x x ¹⁾ - . W2R M20 . x x x x - - . W2R					
			64 □ 32A 50A	N20 . x - x - x x . W2R N33F . x - x - x - . W2R						
			88 □ 63A	N40 . x - x - x - . W2R						
3-pole		30°	3	48 □ 20A 32A	M10H . x x x x x ¹⁾ - . W3R M20 . x x x x - - . W3R					
			64 □ 32A 50A	N20 . x - x - x x . W3R N33F . x - x - x - . W3R						
			88 □ 63A	N40 . x - x - x - . W3R						

Start-Stop switches S

Start-switch, 1-pole		30°	1	48 □ 20A 32A	M10H . x x x x x ¹⁾ - . SE M20 . x x x x - - . SE	
			64 □ 32A 50A	N20 . x - x - x x . SE N33F . x - x - x - . SE		
Start-switch, 2-pole		30°	1	48 □ 20A 32A	M10H . x x x x x ¹⁾ - . S2E M20 . x x x x - - . S2E	
			64 □ 32A 50A	N20 . x - x - x x . S2E N33F . x - x - x - . S2E		
Start-switch, 3-pole		30°	2	48 □ 20A 32A	M10H . x x x x x ¹⁾ - . S3E M20 . x x x x - - . S3E	
			64 □ 32A 50A	N20 . x - x - x x . S3E N33F . x - x - x - . S3E		

Bestellbeispiel: AC21 50A base mounting, Start-switch, 3-pole

N33F V S3E

1) Plastic enclosed switches are delivered with switch type M10.

Switching programs



Description	Wiring diagram	Switching angle	Number of cells ↓ Size ↓ AC21	Type	Design				Switch pro-	Escutcheon plate	
					E.	Z.	V.	SMA. P.			
Start-Stop switches S											
Stop-switch, 1-pole		30°	1 48 □ 20A	M10H . x x x x x ¹⁾ - . SA	x	x	x	x	x ¹⁾ -	. SA	
			64 □ 32A	M20 . x x x x - - . SA	x	x	x	x	- -	. SA	
			88 □ 63A	N20 . x - x - x x . SA	x	-	x	-	x	x	
Stop-switch, 2-pole		30°	1 48 □ 20A	M10H . x x x x x ¹⁾ - . S2A	x	x	x	x	x ¹⁾ -	. S2A	
64 □ 32A	M20 . x x x x - - . S2A	x	x	x	x	- -	. S2A				
88 □ 63A	N20 . x - x - x x . S2A	x	-	x	-	x	x	. S2A			
Stop-switch, 3-pole		30°	2 48 □ 20A	M10H . x x x x x ¹⁾ - . S3A	x	x	x	x	x ¹⁾ -	. S3A	
64 □ 32A	M20 . x x x x - - . S3A	x	x	x	x	- -	. S3A				
88 □ 63A	N20 . x - x - x x . S3A	x	-	x	-	x	x	. S3A			
Start-Stop-switch, 1-pole		30°	1 48 □ 20A	M10H . x x x x x ¹⁾ - . SEA	x	x	x	x	x ¹⁾ -	. SEA	
64 □ 32A	M20 . x x x x - - . SEA	x	x	x	x	- -	. SEA				
88 □ 63A	N20 . x - x - x x . SEA	x	-	x	-	x	x	. SEA			
Start-Stop-switch, 1-pole position START with spring return to 1		90° + 30°	1 48 □ 20A	M10H . x x x x x ¹⁾ - . S392	x	x	x	x	x ¹⁾ -	. S392	
64 □ 32A	M20 . x x x x - - . S392	x	x	x	x	- -	. S392				
88 □ 63A	N20 . x - x - x x . S392	x	-	x	-	x	x	. S392			
Start-Stop-switch, 1-pole for reversing contactors		60° + 30°	2 48 □ 20A	M10H . x x x x x ¹⁾ - . S2EA	x	x	x	x	x ¹⁾ -	. S2EA	
64 □ 32A	M20 . x x x x - - . S2EA	x	x	x	x	- -	. S2EA				
88 □ 63A	N20 . x - x - x x . S2EA	x	-	x	-	x	x	. S2EA			
Start-Stop-switch, 1-pole for reversing contactors with limit switches		30°	2 48 □ 20A	M10H . x x x x x ¹⁾ - . S22	x	x	x	x	x ¹⁾ -	. S22	
64 □ 32A	M20 . x x x x - - . S22	x	x	x	x	- -	. S22				
88 □ 63A	N20 . x - x - x x . S22	x	-	x	-	x	x	. S22			

Ordering example: AC21 50A panel mounting, Start-Stop-switch, 1-pole for reversing contactors

N33F E S2EA

1) Plastic enclosed switches are delivered with switch type M10.

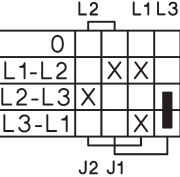
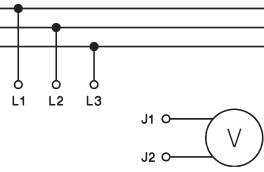
Switching programs

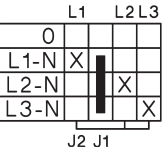
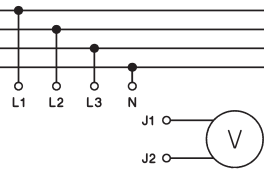
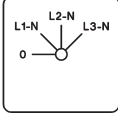
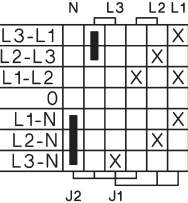
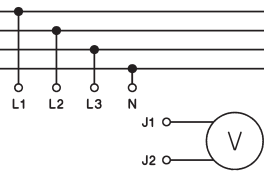
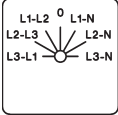
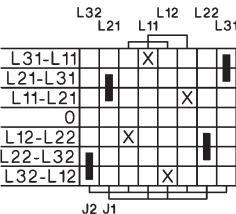
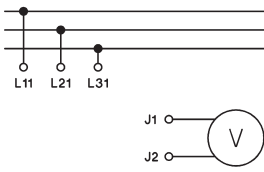
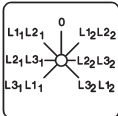
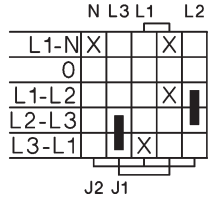
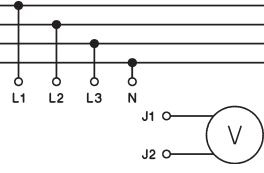
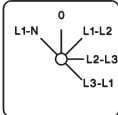
Description	Wiring diagram	Switching angle	Number of cells		Type	Design				Switch pro-	Escutcheon plate		
			↓ Size	↓ AC21		E.	Z.	V.	SMA.			P.	
3 line voltages 		45°	2	48 □ 20A	M10H .	x	x	x	x	x ¹⁾	-	. V3	
				64 □ 32A	M20 .	x	x	x	x	-	-	-	
				64 □ 32A	N20 .	x	-	x	-	x	x	. V3	
				50A	N33F .	x	x	x	-	x	-	. V3	
3 phase voltages 		45°	2	48 □ 20A	M10H .	x	x	x	x	x ¹⁾	-	. V0	
				64 □ 32A	M20 .	x	x	x	x	-	-	-	
				64 □ 32A	N20 .	x	-	x	-	x	x	. V0	
				50A	N33F .	x	x	x	-	x	-	. V0	
3 line voltages and 3 phase voltages 		30°	3	48 □ 20A	M10H .	x	x	x	x	x ¹⁾	-	. V1	
				64 □ 32A	M20 .	x	x	x	x	-	-	-	
				64 □ 32A	N20 .	x	-	x	-	x	x	. V1	
				50A	N33F .	x	x	x	-	x	-	. V1	
2 3-phase systems 2 x 3 line voltages 		45°	4	48 □ 20A	M10H .	x	x	x	x	x ¹⁾	-	. V32	
				64 □ 32A	M20 .	x	x	x	x	-	-	-	
				64 □ 32A	N20 .	x	-	x	-	x	x	. V32	
				50A	N33F .	x	-	x	-	x	-	. V32	
3 line voltages and 1 phase voltage 		45°	3	48 □ 20A	M10H .	x	x	x	x	x ¹⁾	-	. V13	
				64 □ 32A	M20 .	x	x	x	x	-	-	-	
				64 □ 32A	N20 .	x	-	x	-	x	x	. V13	
				50A	N33F .	x	x	x	-	x	-	. V13	

Ordering example: AC21 50A panel mounting, Voltmeter selector switch, 3 line voltages and 1 phase voltage

N33F E V13

1) Plastic enclosed switches are delivered with switch type M10.

Switching programs

Description	Wiring diagram	Switching angle	Number of cells ↓ Size ↓ AC21	Type	Design				Switch pro-	Escutcheon plate			
					E.	Z.	V.	SMA.			P.		
Ammeter selector switches M													
1-pole, for current transformer		90°	1	48 □ 20A	M10H . x x x x x ¹⁾ - . M11 M20 . x x x x - - . M11	x	x	x	x	x ¹⁾	-	. M11	
			64 □ 32A	N20 . x - x - x x . M11 N33F . x x x - x - . M11	x	-	x	-	x	x	.	M11	
			88 □ 63A	N40 . x - x - x - . M11	x	-	x	-	x	-	.	M11	
2-pole, for 1 current transformer or direct current measurement		90°	2	48 □ 20A	M10H . x x x x x ¹⁾ - . M12 M20 . x x x x - - . M12	x	x	x	x	x ¹⁾	-	. M12	
			64 □ 32A	N20 . x - x - x x . M12 N33F . x x x - x - . M12	x	-	x	-	x	x	.	M12	
			88 □ 63A	N40 . x - x - x - . M12 N60 . x - x - x - . M12 N80 . x - x - - - . M12	x	-	x	-	x	-	.	M12	
			132 □ 150A	N100 . x - x - - - . M12 N200 . x - x - - - . M12	x	-	x	-	-	-	.	M12	
1-pole, for 2 current transformers		90°	2	48 □ 20A	M10H . x x x x x ¹⁾ - . M21 M20 . x x x x - - . M21	x	x	x	x	x ¹⁾	-	. M21	
			64 □ 32A	N20 . x - x - x x . M21 N33F . x x x - x - . M21	x	-	x	-	x	x	.	M21	
			88 □ 63A	N40 . x - x - x - . M21	x	-	x	-	x	-	.	M21	
2-pole, for 2 current transformers or direct current measurement in 2 phases		90°	3	48 □ 20A	M10H . x x x x x ¹⁾ - . M22 M20 . x x x x - - . M22	x	x	x	x	x ¹⁾	-	. M22	
			64 □ 32A	N20 . x - x - x x . M22 N33F . x x x - x - . M22	x	-	x	-	x	x	.	M22	
			88 □ 63A	N40 . x - x - x - . M22 N60 . x - x - x - . M22 N80 . x - x - - - . M22	x	-	x	-	x	-	.	M22	
			132 □ 150A	N100 . x - x - - - . M22 N200 . x - x - - - . M22	x	-	x	-	-	-	.	M22	
1-pole, for 3 current transformers		90°	3	48 □ 20A	M10H . x x x x x ¹⁾ - . M31 M20 . x x x x - - . M31	x	x	x	x	x ¹⁾	-	. M31	
			64 □ 32A	N20 . x - x - x x . M31 N33F . x - x - x - . M31	x	-	x	-	x	x	.	M31	
			88 □ 63A	N40 . x - x - x - . M31	x	-	x	-	x	-	.	M31	

Ordering example: AC21 63A panel mounting, ammeter selector switch, for 3 current transformers 1-pole

N40 V M31

1) Plastic enclosed switches are delivered with switch type M10.

Switching programs

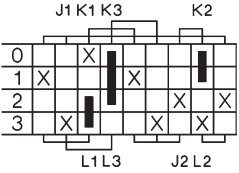
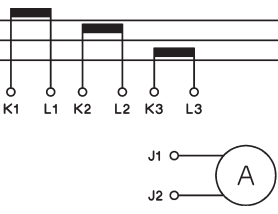
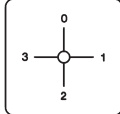
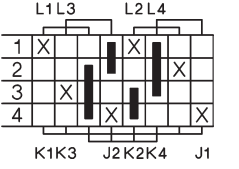
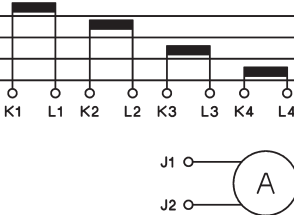
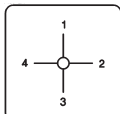
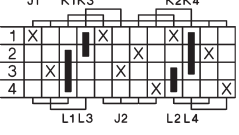
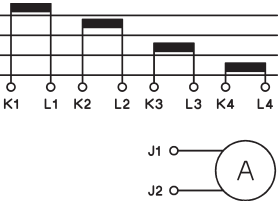
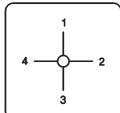
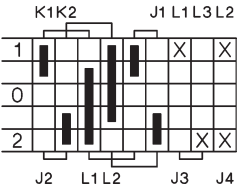
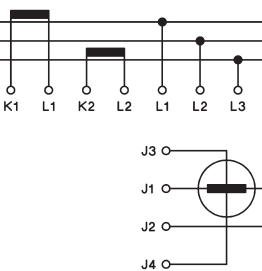
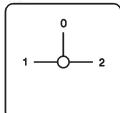





Description	Wiring diagram	Switching angle	Number of cells ↓ Size ↓ AC21	Type	Design				Switch pro-	Escutcheon plate			
					E.	Z.	V.	SMA. P.					
2-pole, for 3 current transformers or direct current measurement in 3 phases 		90°	6	48 □ 20A	M10H .	x	x	x	x	x ¹⁾ -	. M32		
				32A	M20 .	x	x	x	-	-	-		. M32
				64 □ 32A	N20 .	x	-	x	-	x	x		. M32
				50A	N33F .	x	-	x	-	x	-		. M32
				88 □ 63A	N40 .	x	-	x	-	x	-		. M32
1-pole, for 4 current transformers 		90°	4	48 □ 20A	M10H .	x	x	x	x	x ¹⁾ -	. M41		
				32A	M20 .	x	x	x	x	-	-		. M41
				64 □ 32A	N20 .	x	-	x	-	x	x		. M41
				50A	N33F .	x	-	x	-	x	-		. M41
				88 □ 63A	N40 .	x	-	x	-	x	-		. M41
2-pole, for 4 current transformers or direct current measurement in 4 phases 		90°	6	48 □ 20A	M10H .	x	x	x	x	x ¹⁾ -	. M42		
				32A	M20 .	x	x	x	-	-	-		. M42
				64 □ 32A	N20 .	x	-	x	-	x	x		. M42
				50A	N33F .	x	-	x	-	x	-		. M42
				88 □ 63A	N40 .	x	-	x	-	x	-		. M42
f. output measurement in 3-phase systems by 2-wattmeter method 		90°	5	48 □ 20A	M10H .	x	x	x	x	x ¹⁾ -	. M2W		
				32A	M20 .	x	x	x	x	-	-		. M2W
				64 □ 32A	N20 .	x	-	x	-	x	x		. M2W
				50A	N33F .	x	-	x	-	x	-		. M2W
				88 □ 63A	N40 .	x	-	x	-	x	-		. M2W
				90A	N61 .	x	-	x	-	x	-	. M2W	
				115A	N80 .	x	-	x	-	-	-	. M2W	
				132 □ 150A	N100 .	x	-	x	-	-	-	. M2W	
				250A	N200 .	x	-	x	-	-	-	. M2W	

Ordering example: AC21 63A panel mounting, ammeter selector switch, for 4 current transformers 1-pole

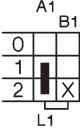
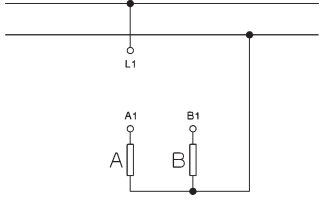
N40 V M41

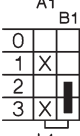
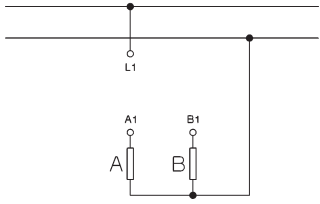
1) Plastic enclosed switches are delivered with switch type M10.

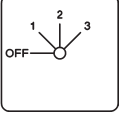
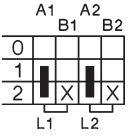
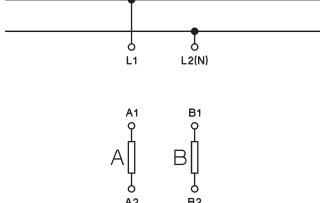
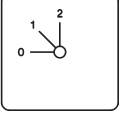
Switching programs

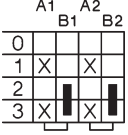
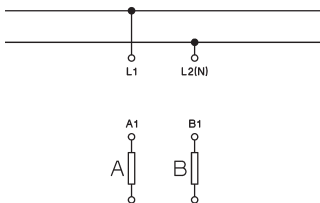
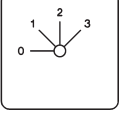
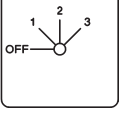
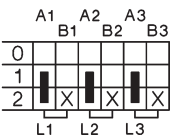
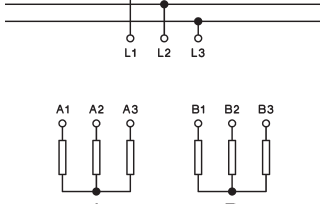
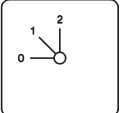
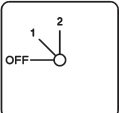
Description	Wiring diagram	Switching angle	Number of cells ↓ Size ↓ AC21	Type	Design				Switch pro-	Escutcheon plate
					E.	Z.	V.	SMA.		
Gang switches GR										
2 circuits A and B 1-pole 0 - A - A+B 		45°	1	48 □ 20A	M10H . x x x x x ¹⁾ - . GR11	M20 . x x x x - - . GR11				
			64 □ 32A	N20 . x - x - x x . GR11	N33F . x x x - x - . GR11					
			88 □ 63A	N40 . x - x - x - . GR11	N61 . x - x - x - . GR11					
			90A	N80 . x - x - - - . GR11						
			115A							
	132 □ 150A	N100 . x - x - - - . GR11	N200 . x - x - - - . GR11						+126	
2 circuits A and B 1-pole 0 - A - B - A+B 		45°	1	48 □ 20A	M10H . x x x x x ¹⁾ - . GR12	M20 . x x x x - - . GR12				
			64 □ 32A	N20 . x - x - x x . GR12	N33F . x x x - x - . GR12					
			88 □ 63A	N40 . x - x - x - . GR12	N61 . x - x - x - . GR12					
			90A	N80 . x - x - - - . GR12						
			115A							
	132 □ 150A	N100 . x - x - - - . GR12	N200 . x - x - - - . GR12						+127	
2 circuits A and B 2-pole 0 - A - A+B 		45°	2	48 □ 20A	M10H . x x x x x ¹⁾ - . GR21	M20 . x x x x - - . GR21				
			64 □ 32A	N20 . x - x - x x . GR21	N33F . x x x - x - . GR21					
			88 □ 63A	N40 . x - x - x - . GR21	N61 . x - x - x - . GR21					
			90A	N80 . x - x - - - . GR21						
			115A							
	132 □ 150A	N100 . x - x - - - . GR21	N200 . x - x - - - . GR21						+126	
2 circuits A and B 2-pole 0 - A - B - A+B 		45°	2	48 □ 20A	M10H . x x x x x ¹⁾ - . GR22	M20 . x x x x - - . GR22				
			64 □ 32A	N20 . x - x - x x . GR22	N33F . x x x - x - . GR22					
			88 □ 63A	N40 . x - x - x - . GR22	N61 . x - x - x - . GR22					
			90A	N80 . x - x - - - . GR22						
			115A							
	132 □ 150A	N100 . x - x - - - . GR22	N200 . x - x - - - . GR22						+127	
2 circuits A and B 3-pole 0 - A - A+B 		45°	3	48 □ 20A	M10H . x x x x x ¹⁾ - . GR31	M20 . x x x x - - . GR31				
			64 □ 32A	N20 . x - x - x x . GR31	N33F . x - x - x - . GR31					
			88 □ 63A	N40 . x - x - x x . GR31	N61 . x - x - x - . GR31					
			90A	N80 . x - x - - - . GR31						
			115A							
	132 □ 150A	N100 . x - x - - - . GR31	N200 . x - x - - - . GR31						+126	

Ordering example: AC21 250A panel mounting, gang switch, 2 circuits A and B, 3-pole **N200 E GR31**

1) Plastic enclosed switches are delivered with switch type M10.

Switching programs

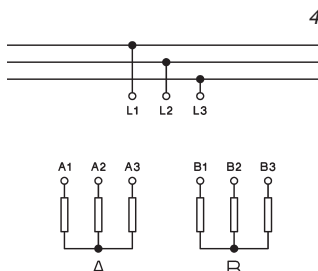
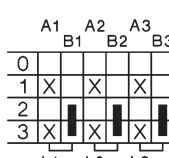
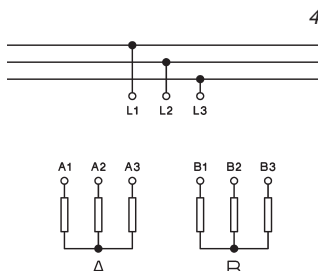
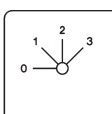
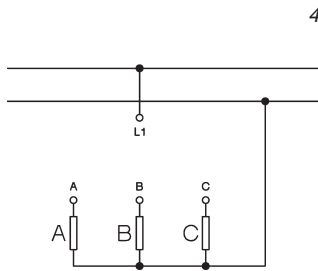
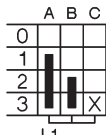
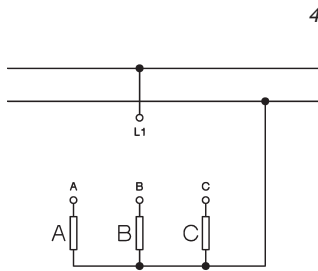
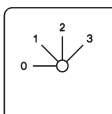
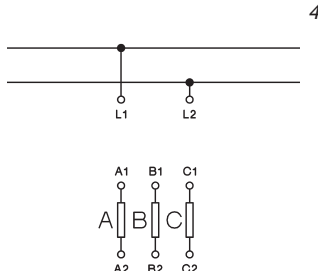
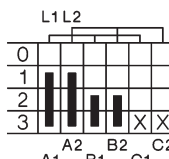
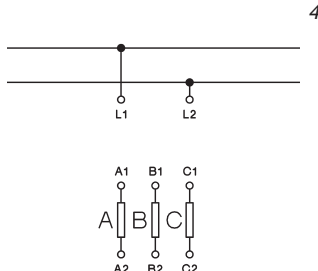
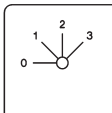
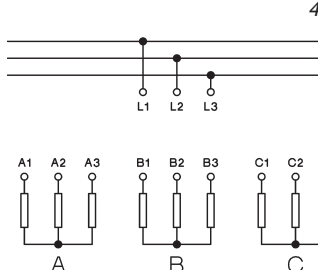
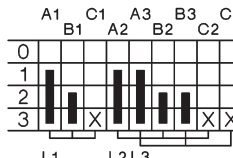
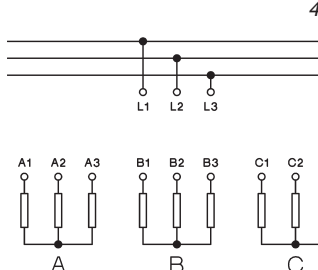
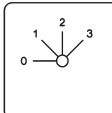
Description	Wiring diagram	Switching angle	Number of cells		Type	Design				Switch pro-	Escutcheon plate
			↓ Size	↓ AC21		E.	Z.	V.	SMA.		
2 circuits A and B 3-pole 0 - A - B - A+B  		45°	3	48 □ 20A 32A	M10H . x x x x x ¹⁾ - . GR32 M20 . x x x x - - . GR32						
			64 □ 32A 50A	N20 . x - x - x x . GR32 N33F . x - x - x - . GR32							
			88 □ 63A 90A 115A	N40 . x - x - x - . GR32 N61 . x - x - x - . GR32 N80 . x - x - - - . GR32							
			132 □ 150A 250A	N100 . x - x - - - . GR32 N200 . x - x - - - . GR32							
3 circuits A, B and C 1-pole 0 - A - A+B - A+B+C  		45°	2	48 □ 20A 32A	M10H . x x x x x ¹⁾ - . GR14 M20 . x x x x - - . GR14						
			64 □ 32A 50A	N20 . x - x - x x . GR14 N33F . x - x - x - . GR14							
			88 □ 63A 90A 115A	N40 . x - x - x - . GR14 N61 . x - x - x - . GR14 N80 . x - x - - - . GR14							
			132 □ 150A 250A	N100 . x - x - - - . GR14 N200 . x - x - - - . GR14							
3 circuits A, B and C 2-pole 0 - A - A+B - A+B+C  		45°	3	48 □ 20A 32A	M10H . x x x x x ¹⁾ - . GR23 M20 . x x x x - - . GR23						
			64 □ 32A 50A	N20 . x - x - x x . GR23 N33F . x - x - x - . GR23							
			88 □ 63A 90A 115A	N40 . x - x - x - . GR23 N61 . x - x - x - . GR23 N80 . x - x - - - . GR23							
			132 □ 150A 250A	N100 . x - x - - - . GR23 N200 . x - x - - - . GR23							
3 circuits A, B and C 3-pole 0 - A - A+B - A+B+C  		45°	5	48 □ 20A 32A	M10H . x x x x x ¹⁾ - . GR33 M20 . x x x x - - . GR33						
			64 □ 32A 50A	N20 . x - x - x x . GR33 N33F . x - x - x - . GR33							
			88 □ 63A 90A 115A	N40 . x - x - x - . GR33 N61 . x - x - x - . GR33 N80 . x - x - - - . GR33							
			132 □ 150A 250A	N100 . x - x - - - . GR33 N200 . x - x - - - . GR33							

Ordering example: AC21 250A panel mounting, gang switch, 3 circuits A, B and C, 3-pole

N200 E GR33

1) Plastic enclosed switches are delivered with switch type M10.

Switching programs

Description	Wiring diagram	Switching angle	Number of cells ↓ Size ↓ AC21	Type	Design				Switch pro-	Escutcheon plate			
					E.	Z.	V.	SMA.			P.		
Series-Parallel switches SP													
2 circuits A and B 2-pole 0 - A + B - A,B (parallel) 		45°	2	48 □ 20A	M10H . x x x x x ¹⁾ - . SP1	x	x	x	x	x ¹⁾	-	. SP1	
			64 □ 32A	N20 . x - x - x x . SP1	x	-	x	-	x	x	.	SP1	
			88 □ 63A	N40 . x - x - x - . SP1	x	-	x	-	x	-	.	SP1	
			90A 115A	N61 . x - x - x - . SP1	x	-	x	-	x	-	.	SP1	
	132 □ 150A	N80 . x - x - - - . SP1	x	-	x	-	-	-	.	SP1	+126 		
250A	N100 . x - x - - - . SP1	x	-	x	-	-	-	.	SP1				
2 circuits A and B 2-pole 0 - A,B (parall.) - A - A+B 		90°	3	48 □ 20A	M10H . x x x x x ¹⁾ - . SP4	x	x	x	x	x ¹⁾	-	. SP4	
			64 □ 32A	N20 . x - x - x x . SP4	x	-	x	-	x	x	.	SP4	
			88 □ 63A	N40 . x - x - x - . SP4	x	-	x	-	x	-	.	SP4	
			90A 115A	N61 . x - x - x - . SP4	x	-	x	-	x	-	.	SP4	
	132 □ 150A	N80 . x - x - - - . SP4	x	-	x	-	-	-	.	SP4	+270 		
250A	N100 . x - x - - - . SP4	x	-	x	-	-	-	.	SP4				
2 circuits A and B for 3-phase systems 0 - A+B - A - B - A,B 		30°	2	48 □ 20A	M10H . x x x x x ¹⁾ - . SP3	x	x	x	x	x ¹⁾	-	. SP3	
			64 □ 32A	N20 . x - x - x x . SP3	x	-	x	-	x	x	.	SP3	
			88 □ 63A	N40 . x - x - x - . SP3	x	-	x	-	x	-	.	SP3	
			90A 115A	N61 . x - x - x - . SP3	x	-	x	-	x	-	.	SP3	
	132 □ 150A	N80 . x - x - - - . SP3	x	-	x	-	-	-	.	SP3	+112 		
250A	N100 . x - x - - - . SP3	x	-	x	-	-	-	.	SP3				

Ordering example: AC21 250A panel mounting, series-parallel switch, 2 circuits for 3-phase systems

N200 E SP3

1) Plastic enclosed switches are delivered with switch type M10.

Switching programs

Description	Wiring diagram	Switching angle	Number of cells ↓ Size ↓ AC21	Type	Design				Switch pro-	Escutcheon plate			
					E.	Z.	V.	SMA.			P.		
Multi step switches 1-pole without Off ST.1													
3 steps		60°	2	48 □ 20A	M10H .	x	x	x	x	x ¹⁾ -	. ST31		
				32A	M20 .	x	x	x	x	- -	. ST31		
				64 □ 32A	N20 .	x	-	x	-	x	x		. ST31
				50A	N33F .	x	x	x	-	x	-		. ST31
				88 □ 63A	N40 .	x	-	x	-	x	-		. ST31
90A	N61 .	x	-	x	-	x	-	. ST31					
115A	N80 .	x	-	x	-	-	-	. ST31					
132 □ 150A	N100 .	x	-	x	-	-	-	. ST31					
250A	N200 .	x	-	x	-	-	-	. ST31					
4 steps		60°	2	48 □ 20A	M10H .	x	x	x	x	x ¹⁾ -	. ST41		
				32A	M20 .	x	x	x	x	- -	. ST41		
				64 □ 32A	N20 .	x	-	x	-	x	x		. ST41
				50A	N33F .	x	x	x	-	x	-		. ST41
				88 □ 63A	N40 .	x	-	x	-	x	-		. ST41
90A	N61 .	x	-	x	-	x	-	. ST41					
115A	N80 .	x	-	x	-	-	-	. ST41					
132 □ 150A	N100 .	x	-	x	-	-	-	. ST41					
250A	N200 .	x	-	x	-	-	-	. ST41					
5 steps		60°	3	48 □ 20A	M10H .	x	x	x	x	x ¹⁾ -	. ST51		
				32A	M20 .	x	x	x	x	- -	. ST51		
				64 □ 32A	N20 .	x	-	x	-	x	x		. ST51
				50A	N33F .	x	x	x	-	x	-		. ST51
				88 □ 63A	N40 .	x	-	x	-	x	-		. ST51
90A	N61 .	x	-	x	-	x	-	. ST51					
115A	N80 .	x	-	x	-	-	-	. ST51					
132 □ 150A	N100 .	x	-	x	-	-	-	. ST51					
250A	N200 .	x	-	x	-	-	-	. ST51					
6 steps		60°	3	48 □ 20A	M10H .	x	x	x	x	x ¹⁾ -	. ST61		
				32A	M20 .	x	x	x	x	- -	. ST61		
				64 □ 32A	N20 .	x	-	x	-	x	x		. ST61
				50A	N33F .	x	x	x	-	x	-		. ST61
				88 □ 63A	N40 .	x	-	x	-	x	-		. ST61
90A	N61 .	x	-	x	-	x	-	. ST61					
115A	N80 .	x	-	x	-	-	-	. ST61					
132 □ 150A	N100 .	x	-	x	-	-	-	. ST61					
250A	N200 .	x	-	x	-	-	-	. ST61					
7 steps		45°	4	48 □ 20A	M10H .	x	x	x	x	x ¹⁾ -	. ST71		
				32A	M20 .	x	x	x	x	- -	. ST71		
				64 □ 32A	N20 .	x	-	x	-	x	x		. ST71
				50A	N33F .	x	-	x	-	x	-		. ST71
				88 □ 63A	N40 .	x	-	x	-	x	-		. ST71
90A	N61 .	x	-	x	-	x	-	. ST71					
115A	N80 .	x	-	x	-	-	-	. ST71					
132 □ 150A	N100 .	x	-	x	-	-	-	. ST71					
250A	N200 .	x	-	x	-	-	-	. ST71					

Ordering example: AC21 250A panel mounting, multi step switch 1-pole without off, 7 steps

N200 E ST71

1) Plastic enclosed switches are delivered with switch type M10.

Switching programs

Description	Wiring diagram	Switching angle	Number of cells ↓ Size ↓ AC21	Type	Design				Switch pro-	Escutcheon plate			
					E.	Z.	V.	SMA.			P.		
Multi step switches 1-pole without Off ST.1													
8 steps		45°	4	48 □ 20A	M10H .	x	x	x	x	x ¹⁾ -	. ST81		
				32A	M20 .	x	x	x	x	-	-		. ST81
				64 □ 32A	N20 .	x	-	x	-	x	x		. ST81
				50A	N33F .	x	-	x	-	x	-		. ST81
				88 □ 63A	N40 .	x	-	x	-	x	-		. ST81
90A	N61 .	x	-	x	-	x	-	. ST81					
115A	N80 .	x	-	x	-	-	-	. ST81					
132 □ 150A	N100 .	x	-	x	-	-	-	. ST81					
250A	N200 .	x	-	x	-	-	-	. ST81					
9 steps		30°	5	48 □ 20A	M10H .	x	x	x	x	x ¹⁾ -	. ST91		
				32A	M20 .	x	x	x	x	-	-		. ST91
				64 □ 32A	N20 .	x	-	x	-	x	x		. ST91
				50A	N33F .	x	-	x	-	x	-		. ST91
				88 □ 63A	N40 .	x	-	x	-	x	-		. ST91
90A	N61 .	x	-	x	-	x	-	. ST91					
115A	N80 .	x	-	x	-	-	-	. ST91					
132 □ 150A	N100 .	x	-	x	-	-	-	. ST91					
250A	N200 .	x	-	x	-	-	-	. ST91					
10 steps		30°	5	48 □ 20A	M10H .	x	x	x	x	x ¹⁾ -	. ST101		
				32A	M20 .	x	x	x	x	-	-		. ST101
				64 □ 32A	N20 .	x	-	x	-	x	x		. ST101
				50A	N33F .	x	-	x	-	x	-		. ST101
				88 □ 63A	N40 .	x	-	x	-	x	-		. ST101
90A	N61 .	x	-	x	-	x	-	. ST101					
115A	N80 .	x	-	x	-	-	-	. ST101					
132 □ 150A	N100 .	x	-	x	-	-	-	. ST101					
250A	N200 .	x	-	x	-	-	-	. ST101					
11 steps		30°	6	48 □ 20A	M10H .	x	x	x	-	x ¹⁾ -	. ST111		
				32A	M20 .	x	x	x	-	-	-		. ST111
				64 □ 32A	N20 .	x	-	x	-	x	x		. ST111
				50A	N33F .	x	-	x	-	x	-		. ST111
				88 □ 63A	N40 .	x	-	x	-	x	-		. ST111
90A	N61 .	x	-	x	-	x	-	. ST111					
115A	N80 .	x	-	x	-	-	-	. ST111					
132 □ 150A	N100 .	x	-	x	-	-	-	. ST111					
250A	N200 .	x	-	x	-	-	-	. ST111					
12 steps		30°	6	48 □ 20A	M10H .	x	x	x	-	x ¹⁾ -	. ST121		
				32A	M20 .	x	x	x	-	-	-		. ST121
				64 □ 32A	N20 .	x	-	x	-	x	x		. ST121
				50A	N33F .	x	-	x	-	x	-		. ST121
				88 □ 63A	N40 .	x	-	x	-	x	-		. ST121
90A	N61 .	x	-	x	-	x	-	. ST121					
115A	N80 .	x	-	x	-	-	-	. ST121					
132 □ 150A	N100 .	x	-	x	-	-	-	. ST121					
250A	N200 .	x	-	x	-	-	-	. ST121					

Ordering example: AC21 250A panel mounting, multi step switch 1-pole without off, 12 steps

N200 E ST121

1) Plastic enclosed switches are delivered with switch type M10.

Switching programs

Description	Wiring diagram	Switching angle	Number of cells ↓ Size ↓ AC21	Type	Design				Switch pro-	Escutcheon plate			
					E.	Z.	V.	SMA. P.					
Multi step switches 1-pole with Off ST0.1													
2 steps		60°	1	48 □ 20A	M10H .	x	x	x	x	x ¹⁾ -	. ST021		
				32A	M20 .	x	x	x	x	- -	. ST021		
				64 □ 32A	N20 .	x	-	x	-	x	x		. ST021
				50A	N33F .	x	x	x	-	x	-		. ST021
				88 □ 63A	N40 .	x	-	x	-	x	-		. ST021
90A	N61 .	x	-	x	-	x	-	. ST021					
115A	N80 .	x	-	x	-	-	-	. ST021					
132 □ 150A	N100 .	x	-	x	-	-	-	. ST021					
250A	N200 .	x	-	x	-	-	-	. ST021					
+422													
3 steps		45°	2	48 □ 20A	M10H .	x	x	x	x	x ¹⁾ -	. ST031		
				32A	M20 .	x	x	x	x	- -	. ST031		
				64 □ 32A	N20 .	x	-	x	-	x	x		. ST031
				50A	N33F .	x	x	x	-	x	-		. ST031
				88 □ 63A	N40 .	x	-	x	-	x	-		. ST031
90A	N61 .	x	-	x	-	x	-	. ST031					
115A	N80 .	x	-	x	-	-	-	. ST031					
132 □ 150A	N100 .	x	-	x	-	-	-	. ST031					
250A	N200 .	x	-	x	-	-	-	. ST031					
+127													
4 steps		30°	2	48 □ 20A	M10H .	x	x	x	x	x ¹⁾ -	. ST041		
				32A	M20 .	x	x	x	x	- -	. ST041		
				64 □ 32A	N20 .	x	-	x	-	x	x		. ST041
				50A	N33F .	x	x	x	-	x	-		. ST041
				88 □ 63A	N40 .	x	-	x	-	x	-		. ST041
90A	N61 .	x	-	x	-	x	-	. ST041					
115A	N80 .	x	-	x	-	-	-	. ST041					
132 □ 150A	N100 .	x	-	x	-	-	-	. ST041					
250A	N200 .	x	-	x	-	-	-	. ST041					
+112													
5 steps		45°	3	48 □ 20A	M10H .	x	x	x	x	x ¹⁾ -	. ST051		
				32A	M20 .	x	x	x	x	- -	. ST051		
				64 □ 32A	N20 .	x	-	x	-	x	x		. ST051
				50A	N33F .	x	x	x	-	x	-		. ST051
				88 □ 63A	N40 .	x	-	x	-	x	-		. ST051
90A	N61 .	x	-	x	-	x	-	. ST051					
115A	N80 .	x	-	x	-	-	-	. ST051					
132 □ 150A	N100 .	x	-	x	-	-	-	. ST051					
250A	N200 .	x	-	x	-	-	-	. ST051					
+423													
6 steps		45°	4	48 □ 20A	M10H .	x	x	x	x	x ¹⁾ -	. ST061		
				32A	M20 .	x	x	x	x	- -	. ST061		
				64 □ 32A	N20 .	x	-	x	-	x	x		. ST061
				50A	N33F .	x	-	x	-	x	-		. ST061
				88 □ 63A	N40 .	x	-	x	-	x	-		. ST061
90A	N61 .	x	-	x	-	x	-	. ST061					
115A	N80 .	x	-	x	-	-	-	. ST061					
132 □ 150A	N100 .	x	-	x	-	-	-	. ST061					
250A	N200 .	x	-	x	-	-	-	. ST061					
+128													

Ordering example: AC21 250A panel mounting, multi step switch 1-pole with off, 6 steps

N200 E ST061

1) Plastic enclosed switches are delivered with switch type M10.

Switching programs

Description	Wiring diagram	Switching angle	Number of cells ↓ Size ↓ AC21	Type	Design				Switch pro-	Escutcheon plate			
					E.	Z.	V.	SMA.			P.		
Multi step switches 1-pole with Off ST0.1													
7 steps		45°	4	48 □ 20A	M10H .	x	x	x	x	x ¹⁾ -	. ST071		
				32A	M20 .	x	x	x	x	-	-		. ST071
				64 □ 32A	N20 .	x	-	x	-	x	x		. ST071
				50A	N33F .	x	-	x	-	x	-		. ST071
				88 □ 63A	N40 .	x	-	x	-	x	-		. ST071
90A	N61 .	x	-	x	-	x	-	. ST071					
115A	N80 .	x	-	x	-	-	-	. ST071					
132 □ 150A	N100 .	x	-	x	-	-	-	. ST071					
250A	N200 .	x	-	x	-	-	-	. ST071					
+ 129													
8 steps		30°	5	48 □ 20A	M10H .	x	x	x	x	x ¹⁾ -	. ST081		
				32A	M20 .	x	x	x	x	-	-		. ST081
				64 □ 32A	N20 .	x	-	x	-	x	x		. ST081
				50A	N33F .	x	-	x	-	x	-		. ST081
				88 □ 63A	N40 .	x	-	x	-	x	-		. ST081
90A	N61 .	x	-	x	-	x	-	. ST081					
115A	N80 .	x	-	x	-	-	-	. ST081					
132 □ 150A	N100 .	x	-	x	-	-	-	. ST081					
250A	N200 .	x	-	x	-	-	-	. ST081					
+ 114													
9 steps		30°	5	48 □ 20A	M10H .	x	x	x	x	x ¹⁾ -	. ST091		
				32A	M20 .	x	x	x	x	-	-		. ST091
				64 □ 32A	N20 .	x	-	x	-	x	x		. ST091
				50A	N33F .	x	-	x	-	x	-		. ST091
				88 □ 63A	N40 .	x	-	x	-	x	-		. ST091
90A	N61 .	x	-	x	-	x	-	. ST091					
115A	N80 .	x	-	x	-	-	-	. ST091					
132 □ 150A	N100 .	x	-	x	-	-	-	. ST091					
250A	N200 .	x	-	x	-	-	-	. ST091					
+ 115													
10 steps		30°	6	48 □ 20A	M10H .	x	x	x	-	x ¹⁾ -	. ST0101		
				32A	M20 .	x	x	x	-	-	-		. ST0101
				64 □ 32A	N20 .	x	-	x	-	x	x		. ST0101
				50A	N33F .	x	-	x	-	x	-		. ST0101
				88 □ 63A	N40 .	x	-	x	-	x	-		. ST0101
90A	N61 .	x	-	x	-	x	-	. ST0101					
115A	N80 .	x	-	x	-	-	-	. ST0101					
132 □ 150A	N100 .	x	-	x	-	-	-	. ST0101					
250A	N200 .	x	-	x	-	-	-	. ST0101					
+ 116													
11 steps		30°	6	48 □ 20A	M10H .	x	x	x	-	x ¹⁾ -	. ST0111		
				32A	M20 .	x	x	x	-	-	-		. ST0111
				64 □ 32A	N20 .	x	-	x	-	x	x		. ST0111
				50A	N33F .	x	-	x	-	x	-		. ST0111
				88 □ 63A	N40 .	x	-	x	-	x	-		. ST0111
90A	N61 .	x	-	x	-	x	-	. ST0111					
115A	N80 .	x	-	x	-	-	-	. ST0111					
132 □ 150A	N100 .	x	-	x	-	-	-	. ST0111					
250A	N200 .	x	-	x	-	-	-	. ST0111					

Ordering example: AC21 250A panel mounting, multi step switch 1-pole with off, 11 steps

N200 E ST0111

1) Plastic enclosed switches are delivered with switch type M10.

Switching programs

Description	Wiring diagram	Switching angle	Number of cells ↓ Size ↓ AC21	Type	Design				Switch pro-	Escutcheon plate
					E.	Z.	V.	SMA.		
Multi step switches 2-pole without Off ST.2										
3 steps		60°	3	48 □ 20A 32A	M10H . x x x x x ¹⁾ - . ST32 M20 . x x x x - - . ST32					
				64 □ 32A 50A	N20 . x - x - x x . ST32 N33F . x x x - x - . ST32					
				88 □ 63A 90A 115A	N40 . x - x - x - . ST32 N61 . x - x - x - . ST32 N80 . x - x - - - . ST32					
				132 □ 150A 250A	N100 . x - x - - - . ST32 N200 . x - x - - - . ST32					
4 steps		60°	4	48 □ 20A 32A	M10H . x x x x x ¹⁾ - . ST42 M20 . x x x x - - . ST42					
				64 □ 32A 50A	N20 . x - x - x x . ST42 N33F . x - x - x - . ST42					
				88 □ 63A 90A 115A	N40 . x - x - x - . ST42 N61 . x - x - x - . ST42 N80 . x - x - - - . ST42					
				132 □ 150A 250A	N100 . x - x - - - . ST42 N200 . x - x - - - . ST42					
5 steps		60°	5	48 □ 20A 32A	M10H . x x x x x ¹⁾ - . ST52 M20 . x x x x - - . ST52					
				64 □ 32A 50A	N20 . x - x - x x . ST52 N33F . x - x - x - . ST52					
				88 □ 63A 90A 115A	N40 . x - x - x - . ST52 N61 . x - x - x - . ST52 N80 . x - x - - - . ST52					
				132 □ 150A 250A	N100 . x - x - - - . ST52 N200 . x - x - - - . ST52					
6 steps		60°	6	48 □ 20A 32A	M10H . x x x - x ¹⁾ - . ST62 M20 . x x x - - - . ST62					
				64 □ 32A 50A	N20 . x - x - x x . ST62 N33F . x - x - x - . ST62					
				88 □ 63A 90A 115A	N40 . x - x - x - . ST62 N61 . x - x - x - . ST62 N80 . x - x - - - . ST62					
				132 □ 150A 250A	N100 . x - x - - - . ST62 N200 . x - x - - - . ST62					
7 steps		45°	7	48 □ 20A 32A	M10H . x x x - - - . ST72 M20 . x x x - - - . ST72					
				64 □ 32A 50A	N20 . x - x - x - . ST72 N33F . x - x - - - . ST72					
				88 □ 63A 90A 115A	N40 . x - x - x - . ST72 N61 . x - x - - - . ST72 N80 . x - x - - - . ST72					
				132 □ 150A 250A	N100 . x - x - - - . ST72 N200 . x - x - - - . ST72					

Ordering example: AC21 250A panel mounting, multi step switch 2-pole without off, 7 steps

N200 E ST72

1) Plastic enclosed switches are delivered with switch type M10.

Switching programs

Description	Wiring diagram	Switching angle	Number of cells ↓ Size ↓ AC21	Type	Design				Switch pro-	Escutcheon plate		
					E.	Z.	V.	SMA. P.				
Multi step switches 2-pole without Off ST.2												
8 steps		45°	8 48 □ 20A	M10H . x x x - - - . ST82	x	x	x	-	-	-	. ST82	
			32A	M20 . x x x - - - . ST82	x	x	x	-	-	-	. ST82	
			64 □ 32A	N20 . x - x - - - . ST82	x	-	x	-	-	-	. ST82	
			50A	N33F . x - x - - - . ST82	x	-	x	-	-	-	. ST82	
			88 □ 63A	N40 . x - x - - - . ST82	x	-	x	-	-	-	. ST82	
90A	N61 . x - x - - - . ST82	x	-	x	-	-	-	. ST82				
115A	N80 . x - x - - - . ST82	x	-	x	-	-	-	. ST82				
132 □ 150A	N100 . x - x - - - . ST82	x	-	x	-	-	-	. ST82				
250A	N200 . x - x - - - . ST82	x	-	x	-	-	-	. ST82				
9 steps		30°	9 48 □ 20A	M10H . x x x - - - . ST92	x	x	x	-	-	-	. ST92	
			32A	M20 . x x x - - - . ST92	x	x	x	-	-	-	. ST92	
			64 □ 32A	N20 . x - x - - - . ST92	x	-	x	-	-	-	. ST92	
			50A	N33F . x - x - - - . ST92	x	-	x	-	-	-	. ST92	
			88 □ 63A	N40 . x - x - - - . ST92	x	-	x	-	-	-	. ST92	
90A	N61 . x - x - - - . ST92	x	-	x	-	-	-	. ST92				
115A	N80 . x - x - - - . ST92	x	-	x	-	-	-	. ST92				
132 □ 150A	N100 . x - x - - - . ST92	x	-	x	-	-	-	. ST92				
250A	N200 . x - x - - - . ST92	x	-	x	-	-	-	. ST92				
10 steps		30°	10 48 □ 20A	M10H . x x x - - - . ST102	x	x	x	-	-	-	. ST102	
			32A	M20 . x x x - - - . ST102	x	x	x	-	-	-	. ST102	
			64 □ 32A	N20 . x - x - - - . ST102	x	-	x	-	-	-	. ST102	
			50A	N33F . x - x - - - . ST102	x	-	x	-	-	-	. ST102	
			88 □ 63A	N40 . x - x - - - . ST102	x	-	x	-	-	-	. ST102	
90A	N61 . x - x - - - . ST102	x	-	x	-	-	-	. ST102				
115A	N80 . x - x - - - . ST102	x	-	x	-	-	-	. ST102				
132 □ 150A	N100 . x - x - - - . ST102	x	-	x	-	-	-	. ST102				
250A	N200 . x - x - - - . ST102	x	-	x	-	-	-	. ST102				
11 steps		30°	11 48 □ 20A	M10H . x x x - - - . ST112	x	x	x	-	-	-	. ST112	
			32A	M20 . x x x - - - . ST112	x	x	x	-	-	-	. ST112	
			64 □ 32A	N20 . x - x - - - . ST112	x	-	x	-	-	-	. ST112	
			50A	N33F . x - x - - - . ST112	x	-	x	-	-	-	. ST112	
			88 □ 63A	N40 . x - x - - - . ST112	x	-	x	-	-	-	. ST112	
90A	N61 . x - x - - - . ST112	x	-	x	-	-	-	. ST112				
115A	N80 . x - x - - - . ST112	x	-	x	-	-	-	. ST112				
132 □ 150A	N100 . x - x - - - . ST112	x	-	x	-	-	-	. ST112				
250A	N200 . x - x - - - . ST112	x	-	x	-	-	-	. ST112				
12 steps		30°	12 48 □ 20A	M10H . x x x - - - . ST122	x	x	x	-	-	-	. ST122	
			32A	M20 . x x x - - - . ST122	x	x	x	-	-	-	. ST122	
			64 □ 32A	N20 . x - x - - - . ST122	x	-	x	-	-	-	. ST122	
			50A	N33F . x - x - - - . ST122	x	-	x	-	-	-	. ST122	
			88 □ 63A	N40 . x - x - - - . ST122	x	-	x	-	-	-	. ST122	
90A	N61 . x - x - - - . ST122	x	-	x	-	-	-	. ST122				
115A	N80 . x - x - - - . ST122	x	-	x	-	-	-	. ST122				
132 □ 150A	N100 . x - x - - - . ST122	x	-	x	-	-	-	. ST122				
250A	N200 . x - x - - - . ST122	x	-	x	-	-	-	. ST122				

Ordering example: AC21 250A panel mounting, multi step switch 2-pole without off, 12 steps

N200 E ST122

Switching programs

Description	Wiring diagram	Switching angle	Number of cells ↓ Size ↓ AC21	Type	Design				Switch pro-	Escutcheon plate		
					E.	Z.	V.	SMA.			P.	
Multi step switches 2-pole with Off ST0.2												
2 steps		60°	2 48 □ 20A	M10H . x x x x x ¹⁾ - . ST022	x	x	x	x	x ¹⁾ -	. ST022		
			32A	M20 . x x x x x - - . ST022	x	x	x	x	- -	. ST022		
			64 □ 32A	N20 . x - x - x x . ST022	x	-	x	-	x	x		. ST022
			50A	N33F . x x x - x - . ST022	x	x	x	-	x	-		. ST022
			88 □ 63A	N40 . x - x - x - . ST022	x	-	x	-	x	-		. ST022
90A	N61 . x - x - x - . ST022	x	-	x	-	x	-	. ST022				
115A	N80 . x - x - - - . ST022	x	-	x	-	-	-	. ST022				
132 □ 150A	N100 . x - x - - - . ST022	x	-	x	-	-	-	. ST022	+422 			
250A	N200 . x - x - - - . ST022	x	-	x	-	-	-	. ST022				
3 steps		45°	3 48 □ 20A	M10H . x x x x x ¹⁾ - . ST032	x	x	x	x		x ¹⁾ -	. ST032	
			32A	M20 . x x x x x - - . ST032	x	x	x	x		- -	. ST032	
			64 □ 32A	N20 . x - x - x x . ST032	x	-	x	-		x	x	
			50A	N33F . x x x - x - . ST032	x	x	x	-	x	-	. ST032	
			88 □ 63A	N40 . x - x - x - . ST032	x	-	x	-	x	-	. ST032	
90A	N61 . x - x - x - . ST032	x	-	x	-	x	-	. ST032				
115A	N80 . x - x - - - . ST032	x	-	x	-	-	-	. ST032				
132 □ 150A	N100 . x - x - - - . ST032	x	-	x	-	-	-	. ST032	+127 			
250A	N200 . x - x - - - . ST032	x	-	x	-	-	-	. ST032				
4 steps		30°	4 48 □ 20A	M10H . x x x x x ¹⁾ - . ST042	x	x	x	x		x ¹⁾ -	. ST042	
			32A	M20 . x x x x x - - . ST042	x	x	x	x		- -	. ST042	
			64 □ 32A	N20 . x - x - x x . ST042	x	-	x	-		x	x	
			50A	N33F . x - x - x - . ST042	x	-	x	-	x	-	. ST042	
			88 □ 63A	N40 . x - x - x - . ST042	x	-	x	-	x	-	. ST042	
90A	N61 . x - x - x - . ST042	x	-	x	-	x	-	. ST042				
115A	N80 . x - x - - - . ST042	x	-	x	-	-	-	. ST042				
132 □ 150A	N100 . x - x - - - . ST042	x	-	x	-	-	-	. ST042	+112 			
250A	N200 . x - x - - - . ST042	x	-	x	-	-	-	. ST042				
5 steps		45°	6 48 □ 20A	M10H . x x x - x ¹⁾ - . ST052	x	x	x	-		x ¹⁾ -	. ST052	
			32A	M20 . x x x - - - . ST052	x	x	x	-		- -	. ST052	
			64 □ 32A	N20 . x - x - x x . ST052	x	-	x	-		x	x	
			50A	N33F . x - x - x - . ST052	x	-	x	-	x	-	. ST052	
			88 □ 63A	N40 . x - x - x - . ST052	x	-	x	-	x	-	. ST052	
90A	N61 . x - x - x - . ST052	x	-	x	-	x	-	. ST052				
115A	N80 . x - x - - - . ST052	x	-	x	-	-	-	. ST052				
132 □ 150A	N100 . x - x - - - . ST052	x	-	x	-	-	-	. ST052	+423 			
250A	N200 . x - x - - - . ST052	x	-	x	-	-	-	. ST052				
6 steps		45°	7 48 □ 20A	M10H . x x x - x ¹⁾ - . ST062	x	x	x	-		x ¹⁾ -	. ST062	
			32A	M20 . x x x - - - . ST062	x	x	x	-		- -	. ST062	
			64 □ 32A	N20 . x - x - x - . ST062	x	-	x	-		x	-	
			50A	N33F . x - x - - - . ST062	x	-	x	-	-	-	. ST062	
			88 □ 63A	N40 . x - x - x - . ST062	x	-	x	-	x	-	. ST062	
90A	N61 . x - x - - - . ST062	x	-	x	-	-	-	. ST062				
115A	N80 . x - x - - - . ST062	x	-	x	-	-	-	. ST062				
132 □ 150A	N100 . x - x - - - . ST062	x	-	x	-	-	-	. ST062	+128 			
250A	N200 . x - x - - - . ST062	x	-	x	-	-	-	. ST062				

Ordering example: AC21 250A panel mounting, multi step switch 2-pole with off, 6 steps

N200 E ST062

1) Plastic enclosed switches are delivered with switch type M10.

Switching programs

Description	Wiring diagram	Switching angle	Number of cells ↓ Size ↓ AC21	Type	Design				Switch pro-	Escutcheon plate
					E.	Z.	V.	SMA. P.		
Multi step switches 2-pole with Off ST0.2										
7 steps		45°	8	48 □ 20A 32A	M10H . x x x - - - . ST072 M20 . x x x - - - . ST072					
				64 □ 32A 50A	N20 . x - x - - - . ST072 N33F . x - x - - - . ST072					
				88 □ 63A 90A 115A	N40 . x - x - x - . ST072 N61 . x - x - - - . ST072 N80 . x - x - - - . ST072				+ 129	
				132 □ 150A 250A	N100 . x - x - - - . ST072 N200 . x - x - - - . ST072					
8 steps		30°	9	48 □ 20A 32A	M10H . x x x - - - . ST082 M20 . x x x - - - . ST082					
				64 □ 32A 50A	N20 . x - x - - - . ST082 N33F . x - x - - - . ST082					
				88 □ 63A 90A 115A	N40 . x - x - - - . ST082 N61 . x - x - - - . ST082 N80 . x - x - - - . ST082				+ 114	
				132 □ 150A 250A	N100 . x - x - - - . ST082 N200 . x - x - - - . ST082					
9 steps		30°	10	48 □ 20A 32A	M10H . x x x - - - . ST092 M20 . x x x - - - . ST092					
				64 □ 32A 50A	N20 . x - x - - - . ST092 N33F . x - x - - - . ST092					
				88 □ 63A 90A 115A	N40 . x - x - - - . ST092 N61 . x - x - - - . ST092 N80 . x - x - - - . ST092				+ 115	
				132 □ 150A 250A	N100 . x - x - - - . ST092 N200 . x - x - - - . ST092					
10 steps		30°	11	48 □ 20A 32A	M10H . x x x - - - . ST0102 M20 . x x x - - - . ST0102					
				64 □ 32A 50A	N20 . x - x - - - . ST0102 N33F . x - x - - - . ST0102					
				88 □ 63A 90A 115A	N40 . x - x - - - . ST0102 N61 . x - x - - - . ST0102 N80 . x - x - - - . ST0102				+ 116	
				132 □ 150A 250A	N100 . x - x - - - . ST0102 N200 . x - x - - - . ST0102					
11 steps		30°	12	48 □ 20A 32A	M10H . x x x - - - . ST0112 M20 . x x x - - - . ST0112					
				64 □ 32A 50A	N20 . x - x - - - . ST0112 N33F . x - x - - - . ST0112					
				88 □ 63A 90A 115A	N40 . x - x - - - . ST0112 N61 . x - x - - - . ST0112 N80 . x - x - - - . ST0112				+ 117	
				132 □ 150A 250A	N100 . x - x - - - . ST0112 N200 . x - x - - - . ST0112					

Ordering example: AC21 250A panel mounting, multi step switch 2-pole with off, 11 steps N200 E ST0112

Switching programs

Description	Wiring diagram	Switching angle	Number of cells ↓ Size ↓ AC21	Type	Design				Switch pro-	Escutcheon plate			
					E.	Z.	V.	SMA. P.					
Multi step switches 3-pole without Off ST.3													
3 steps		60°	5	48 □ 20A 32A	M10H .	x	x	x	x	x ¹⁾ -	. ST33		
				64 □ 32A 50A	N20 .	x	x	x	x	- -	. ST33		
				88 □ 63A 90A 115A	N40 .	x	-	x	-	x	-		. ST33
					N61 .	x	-	x	-	x	-		. ST33
					N80 .	x	-	x	-	-	-		. ST33
		132 □ 150A 250A	N100 .	x	-	x	-	-	-	. ST33			
				N200 .	x	-	x	-	-	-	. ST33		
4 steps		60°	6	48 □ 20A 32A	M10H .	x	x	x	-	x ¹⁾ -	. ST43		
				64 □ 32A 50A	N20 .	x	-	x	-	x	x		. ST43
				88 □ 63A 90A 115A	N40 .	x	-	x	-	x	-		. ST43
					N61 .	x	-	x	-	x	-		. ST43
					N80 .	x	-	x	-	-	-		. ST43
		132 □ 150A 250A	N100 .	x	-	x	-	-	-	. ST43			
				N200 .	x	-	x	-	-	-	. ST43		
5 steps		60°	8	48 □ 20A 32A	M10H .	x	x	x	-	- -	. ST53		
				64 □ 32A 50A	N20 .	x	-	x	-	x	-		. ST53
				88 □ 63A 90A 115A	N40 .	x	-	x	-	x	-		. ST53
					N61 .	x	-	x	-	-	-		. ST53
					N80 .	x	-	x	-	-	-		. ST53
		132 □ 150A 250A	N100 .	x	-	x	-	-	-	. ST53			
				N200 .	x	-	x	-	-	-	. ST53		
6 steps		60°	9	48 □ 20A 32A	M10H .	x	x	x	-	- -	. ST63		
				64 □ 32A 50A	N20 .	x	-	x	-	-	-		. ST63
				88 □ 63A 90A 115A	N40 .	x	-	x	-	-	-		. ST63
					N61 .	x	-	x	-	-	-		. ST63
					N80 .	x	-	x	-	-	-		. ST63
		132 □ 150A 250A	N100 .	x	-	x	-	-	-	. ST63			
				N200 .	x	-	x	-	-	-	. ST63		
7 steps		45°	11	48 □ 20A 32A	M10H .	x	x	x	-	- -	. ST73		
				64 □ 32A 50A	N20 .	x	-	x	-	-	-		. ST73
				88 □ 63A 90A 115A	N40 .	x	-	x	-	-	-		. ST73
					N61 .	x	-	x	-	-	-		. ST73
					N80 .	x	-	x	-	-	-		. ST73
		132 □ 150A 250A	N100 .	x	-	x	-	-	-	. ST73			
				N200 .	x	-	x	-	-	-	. ST73		

Ordering example: AC21 250A panel mounting, multi step switch 3-pole without off, 7 steps

N200 E ST73

1) Plastic enclosed switches are delivered with switch type M10.

Switching programs

Description	Wiring diagram	Switching angle	Number of cells ↓ Size ↓ AC21	Type	Design				Switch pro-	Escutcheon plate
					E.	Z.	V.	SMA. P.		
Multi step switches 3-pole without Off ST.3										
8 steps		45°	12 48 □ 20A	M10H . x x x - - - . ST83 M20 . x x x - - - . ST83						
			64 □ 32A 50A	N20 . x - x - - - . ST83 N33F . x - x - - - . ST83						
			88 □ 63A 90A 115A	N40 . x - x - - - . ST83 N61 . x - x - - - . ST83 N80 . x - x - - - . ST83						
			132 □ 150A 250A	N100 . x - x - - - . ST83 N200 . x - x - - - . ST83						
			9 steps			30°	14 48 □ 20A	M10H . x - x - - - . ST93 M20 . x - x - - - . ST93		
64 □ 32A 50A	N20 . x - x - - - . ST93 N33F . x - x - - - . ST93									
88 □ 63A 90A 115A	N40 . x - x - - - . ST93 N61 . x - x - - - . ST93 N80 . x - x - - - . ST93									
132 □ 150A 250A	N100 . x - x - - - . ST93 N200 . x - x - - - . ST93									
10 steps		30°	15 48 □ 20A		M10H . x - x - - - . ST103 M20 . x - x - - - . ST103					
64 □ 32A 50A			N20 . x - x - - - . ST103 N33F . x - x - - - . ST103							
88 □ 63A 90A 115A			N40 . x - x - - - . ST103 N61 . x - x - - - . ST103 N80 . x - x - - - . ST103							
132 □ 150A 250A			N100 . x - x - - - . ST103 N200 . x - x - - - . ST103							
11 steps				30°	17 48 □ 20A	M10H . x - x - - - . ST113 M20 . x - x - - - . ST113				
64 □ 32A 50A	N20 . x - x - - - . ST113 N33F . x - x - - - . ST113									
88 □ 63A 90A 115A	N40 . x - x - - - . ST113 N61 . x - x - - - . ST113 N80 . x - x - - - . ST113									
132 □ 150A 250A	N100 . x - x - - - . ST113 N200 . x - x - - - . ST113									
12 steps		30°			18 48 □ 20A	M10H . x - x - - - . ST123 M20 . x - x - - - . ST123				
64 □ 32A 50A			N20 . x - x - - - . ST123 N33F . x - x - - - . ST123							
88 □ 63A 90A 115A			N40 . x - x - - - . ST123 N61 . x - x - - - . ST123 N80 . x - x - - - . ST123							
132 □ 150A 250A			N100 . x - x - - - . ST123 N200 . x - x - - - . ST123							

Ordering example: AC21 250A panel mounting, multi step switch 3-pole without off, 12 steps

N200 E ST123

Switching programs

Description	Wiring diagram	Switching angle	Number of cells ↓ Size ↓ AC21	Type	Design				Switch pro-	Escutcheon plate			
					E.	Z.	V.	SMA.			P.		
Multi step switches 3-pole with Off ST0.3													
2 steps		60°	3	48 □ 20A	M10H .	x	x	x	x	x ¹⁾	-	. ST023	
				32A	M20 .	x	x	x	x	-	-	. ST023	
				64 □ 32A	N20 .	x	-	x	-	x	x	. ST023	
				50A	N33F .	x	x	x	-	x	-	. ST023	
				88 □ 63A	N40 .	x	-	x	-	x	-	. ST023	
90A	N61 .	x	-	x	-	x	-	. ST023					
115A	N80 .	x	-	x	-	-	-	. ST023					
132 □ 150A	N100 .	x	-	x	-	-	-	. ST023					
250A	N200 .	x	-	x	-	-	-	. ST023					
3 steps		45°	5	48 □ 20A	M10H .	x	x	x	x	x ¹⁾	-	. ST033	
				32A	M20 .	x	x	x	x	-	-	. ST033	
				64 □ 32A	N20 .	x	-	x	-	x	x	. ST033	
				50A	N33F .	x	-	x	-	x	-	. ST033	
				88 □ 63A	N40 .	x	-	x	-	x	-	. ST033	
90A	N61 .	x	-	x	-	x	-	. ST033					
115A	N80 .	x	-	x	-	-	-	. ST033					
132 □ 150A	N100 .	x	-	x	-	-	-	. ST033					
250A	N200 .	x	-	x	-	-	-	. ST033					
4 steps		30°	6	48 □ 20A	M10H .	x	x	x	-	x ¹⁾	-	. ST043	
				32A	M20 .	x	x	x	-	-	-	. ST043	
				64 □ 32A	N20 .	x	-	x	-	x	x	. ST043	
				50A	N33F .	x	-	x	-	x	-	. ST043	
				88 □ 63A	N40 .	x	-	x	-	x	-	. ST043	
90A	N61 .	x	-	x	-	x	-	. ST043					
115A	N80 .	x	-	x	-	-	-	. ST043					
132 □ 150A	N100 .	x	-	x	-	-	-	. ST043					
250A	N200 .	x	-	x	-	-	-	. ST043					
5 steps		45°	9	48 □ 20A	M10H .	x	x	x	-	-	-	. ST053	
				32A	M20 .	x	x	x	-	-	-	. ST053	
				64 □ 32A	N20 .	x	-	x	-	-	-	. ST053	
				50A	N33F .	x	-	x	-	-	-	. ST053	
				88 □ 63A	N40 .	x	-	x	-	-	-	. ST053	
90A	N61 .	x	-	x	-	-	-	. ST053					
115A	N80 .	x	-	x	-	-	-	. ST053					
132 □ 150A	N100 .	x	-	x	-	-	-	. ST053					
250A	N200 .	x	-	x	-	-	-	. ST053					
6 steps		45°	11	48 □ 20A	M10H .	x	x	x	-	-	-	. ST063	
				32A	M20 .	x	x	x	-	-	-	. ST063	
				64 □ 32A	N20 .	x	-	x	-	-	-	. ST063	
				50A	N33F .	x	-	x	-	-	-	. ST063	
				88 □ 63A	N40 .	x	-	x	-	-	-	. ST063	
90A	N61 .	x	-	x	-	-	-	. ST063					
115A	N80 .	x	-	x	-	-	-	. ST063					
132 □ 150A	N100 .	x	-	x	-	-	-	. ST063					
250A	N200 .	x	-	x	-	-	-	. ST063					

Ordering example: AC21 250A panel mounting, multi step switch 3-pole with off, 6 steps **N200 E ST063**

1) Plastic enclosed switches are delivered with switch type M10.

Switching programs

Description	Wiring diagram	Switching angle	Number of cells ↓ Size ↓ AC21	Type	Design				Switch pro-	Escutcheon plate
					E.	Z.	V.	SMA. P.		
Multi step switches 3-pole with Off ST0.3										
7 steps		45°	12 48 □ 20A	M10H . x x x - - - . ST073 M20 . x x x - - - . ST073						
			64 □ 32A 50A	N20 . x - x - - - . ST073 N33F . x - x - - - . ST073						
			88 □ 63A 90A 115A	N40 . x - x - - - . ST073 N61 . x - x - - - . ST073 N80 . x - x - - - . ST073						
			132 □ 150A 250A	N100 . x - x - - - . ST073 N200 . x - x - - - . ST073						
							+ 129			
8 steps		30°	14 48 □ 20A	M10H . x - x - - - . ST083 M20 . x - x - - - . ST083						
			64 □ 32A 50A	N20 . x - x - - - . ST083 N33F . x - x - - - . ST083						
			88 □ 63A 90A 115A	N40 . x - x - - - . ST083 N61 . x - x - - - . ST083 N80 . x - x - - - . ST083						
			132 □ 150A 250A	N100 . x - x - - - . ST083 N200 . x - x - - - . ST083						
							+ 114			
9 steps		30°	15 48 □ 20A	M10H . x - x - - - . ST093 M20 . x - x - - - . ST093						
			64 □ 32A 50A	N20 . x - x - - - . ST093 N33F . x - x - - - . ST093						
			88 □ 63A 90A 115A	N40 . x - x - - - . ST093 N61 . x - x - - - . ST093 N80 . x - x - - - . ST093						
			132 □ 150A 250A	N100 . x - x - - - . ST093 N200 . x - x - - - . ST093						
							+ 115			
10 steps		30°	17 48 □ 20A	M10H . x - x - - - . ST0103 M20 . x - x - - - . ST0103						
			64 □ 32A 50A	N20 . x - x - - - . ST0103 N33F . x - x - - - . ST0103						
			88 □ 63A 90A 115A	N40 . x - x - - - . ST0103 N61 . x - x - - - . ST0103 N80 . x - x - - - . ST0103						
			132 □ 150A 250A	N100 . x - x - - - . ST0103 N200 . x - x - - - . ST0103						
							+ 116			
11 steps		30°	18 48 □ 20A	M10H . x - x - - - . ST0113 M20 . x - x - - - . ST0113						
			64 □ 32A 50A	N20 . x - x - - - . ST0113 N33F . x - x - - - . ST0113						
			88 □ 63A 90A 115A	N40 . x - x - - - . ST0113 N61 . x - x - - - . ST0113 N80 . x - x - - - . ST0113						
			132 □ 150A 250A	N100 . x - x - - - . ST0113 N200 . x - x - - - . ST0113						
							+ 117			

Ordering example: AC21 250A panel mounting, multi step switch 3-pole with off, 11 steps

N200 E ST0113

Mini-Cam Switches M4H

Panel mounting E, IP40

Central fixing Z

Central fixing without escutcheon plate ZO

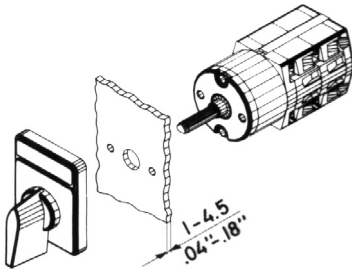
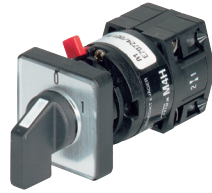

Mounting holes

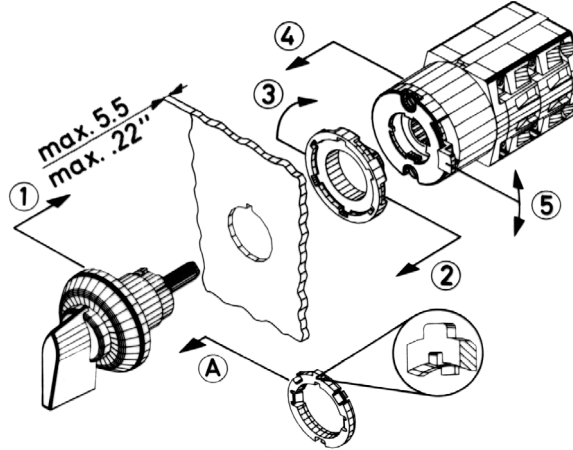
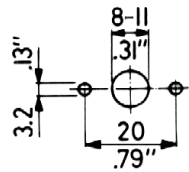

Central fixing 16mm

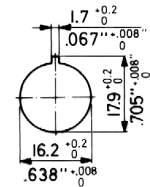

lock

unlock Central fixing 22mm

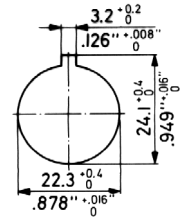

Single hole mountings are generally delivered for a 16mm (.64") mounting. Using the forwarded adapter ring, it is possible to alter the single hole mountings from 22mm (.88"). For that purpose the adapter ring has to be attached onto the threaded part of the body in such a manner, that
 1. the flat side of the adapter ring shows towards the front seal and
 2. the inner nose fits into the notch of the body.
 The adapter ring has to be pushed towards the front seal.

Optional extras	ordering code	for design	M4H Z ... +SRE	M4H Z ... +SA.	M4H ZO ... +SA.	M4H Z ... +SRE+SA.
Additional escutcheon plate	+SRE	E, Z, ZO				
Additional escutcheon plate	+SRE2	E, Z, ZO				
Key operated switch with lock KABA	+SA1	Z, ZO				
with lock Ronis	+SA2	Z, ZO				

Wrench J7400
for switches M4H with central fixing is necessary

Panel mounting E

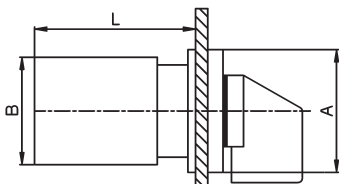

Central fixing Z, ZO

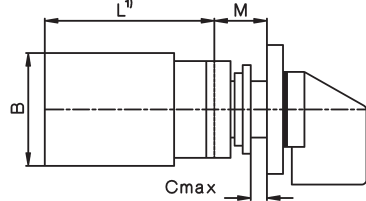

ZO

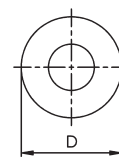

Z

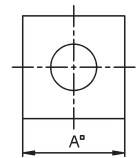

Type	A	B	D	M	Dimension L for ... cells								
					1	2	3	4	5	6	7	8	
M4H	mm	30	28	29,5	12,5	38,5	50,5	62,5	74,5	86,5	98,5	110,5	122,5

Technical data

Type	according to specifications	AC21A	AC15		Volt	Motor rating AC3						
			110V	380V		3 phase 3-pole			1 phase 2-pole			
M4H	IEC, VDE, BS, SEV UL, CSA	General use 10A/500V 10A/300V	2,5A	1,5A	kW HP	0,65	1,5	2,2	0,3	0,55	-	0,75
			A300	-		-	0,33	0,75	0,75	-		

Type	according to specifications	Volt	Motor rating AC23			2-pole		
			3-pole	110	220	380	110	220
M4H	IEC, VDE, BS, SEV UL, CSA	kW HP	0,75	1,8	3	0,37	0,75	1,1
			-	-	-	-	-	-

additional data for wiring according to UL and CSA

Type	type of wire	temp. rating of wire	torque value for field wiring terminals
M4H	copper wire only	60/75°C	0,4Nm / 3,5lb - inch

Mini-Cam Switches M4H

Switch programs

Description	Wiring diagram	AC21 500V 10A AC15 230V 2,5A AC3 4x400V 2,2kW	escutch. 30 x 30	numb. of cells	Type	Design			Switch pro- gram
						.E. ↓	.Z. ↓	.ZO. ↓	
On-Off-switch A									
1-pole				1	M4H .	x	x	x	. A1
2-pole				1	M4H .	x	x	x	. A2
3-pole				2	M4H .	x	x	x	. A3
4-pole				2	M4H .	x	x	x	. A4
6-pole				3	M4H .	x	x	x	. A6
Changeover switch U									
1-pole				1	M4H .	x	x	x	. U1
2-pole				2	M4H .	x	x	x	. U2
3-pole				3	M4H .	x	x	x	. U3
4-pole				4	M4H .	x	x	x	. U4
Changeover switch without off W									
1-pole				1	M4H .	x	x	x	. W1
2-pole				2	M4H .	x	x	x	. W2
3-pole				3	M4H .	x	x	x	. W3
4-pole				4	M4H .	x	x	x	. W4
6-pole				6	M4H .	x	x	x	. W6
Reversing switch WU									
2-pole				2	M4H .	x	x	x	. WU2
3-pole				3	M4H .	x	x	x	. WU3
3-pole with spring return to 0				3	M4H .	x	x	x	. WU3R2
Star-delta switch SD									
1 rotary direction				4	M4H .	x	x	x	. SD
both rotary directions				5	M4H .	x	x	x	. SDR
Changeover with spring return UR									
1-pole				1	M4H .	x	x	x	. UR1
2-pole				2	M4H .	x	x	x	. UR2
3-pole				3	M4H .	x	x	x	. UR3
Start switch									
1-pole				1	M4H .	x	x	x	. SE
Stop switch									
1-pole				1	M4H .	x	x	x	. SA

Ordering example: Stop switch, 1-pole, Central fixing: **M4H Z SA**

Mini-Cam Switches M4H

Switch programs

Description	Wiring diagram	AC21 500V 10A AC15 230V 2,5A AC3 4x400V 2,2kW	escutch. 30 x 30	numb. of cells	Type	Design			Switch program
						.E. ↓	.Z. ↓	.ZO. ↓	
Start-Stop switch				1	M4H .	x	x	x	. SEA
Start-Stop switch position START with spring return to 1				1	M4H .	x	x	x	. S392
Start-Stop switch for reversing contactors				2	M4H .	x	x	x	. S2EA
Voltmeter selector switch V 3 line voltages				2	M4H .	x	x	x	. V3
3 phase voltages				2	M4H .	x	x	x	. V0
3 line voltages 3 phase voltages				3	M4H .	x	x	x	. V1
Ammeter selector switch A 1-pole, 3 current transformer				4	M4H .	x	x	x	. M31
Gang switch GR 2 circuits A and B 1-pole 0 - A - A+B				1	M4H .	x	x	x	. GR11
2 circuits A and B 1-pole 0 - A - B - A+B				1	M4H .	x	x	x	. GR12
3 circuits A, B and C 1-pole				2	M4H .	x	x	x	. GR14
Multi step switch without 0 ST 3 steps, 1-pole				2	M4H .	x	x	x	. ST31
3 steps, 2-pole				3	M4H .	x	x	x	. ST32
3 steps, 3-pole				5	M4H .	x	x	x	. ST33

Ordering example: Multi step switch without 0, 3 steps, 3-pole, panel mounting: **M4H E ST33**



Mini-Cam Switches M4H

Switch programs

Description	Wiring diagram	AC21 500V 10A AC15 230V 2,5A AC3 4x400V 2,2kW	escutch. 30 x 30	numb. of cells	Type	Design			Switch pro- gram
						E. ↓	Z. ↓	ZO. ↓	
Multi step switch without 0 ST									
4 steps, 1-pole				2	M4H	x	x	x	.ST41
4 steps, 2-pole				4	M4H	x	x	x	.ST42
4 steps, 3-pole				6	M4H	x	x	x	.ST43
5 steps, 1-pole				3	M4H	x	x	x	.ST51
5 steps, 2-pole				5	M4H	x	x	x	.ST52
6 steps, 1-pole				3	M4H	x	x	x	.ST61
6 steps, 2-pole				6	M4H	x	x	x	.ST62
Multi step switch with 0 ST0.									
2 steps, 1-pole				1	M4H	x	x	x	.ST021
2 steps, 2-pole				2	M4H	x	x	x	.ST022
2 steps, 3-pole				3	M4H	x	x	x	.ST023
3 steps, 1-pole				2	M4H	x	x	x	.ST031
3 steps, 2-pole				3	M4H	x	x	x	.ST032
3 steps, 3-pole				5	M4H	x	x	x	.ST033
4 steps, 1-pole				2	M4H	x	x	x	.ST041
4 steps, 2-pole				4	M4H	x	x	x	.ST042
4 steps, 3-pole				6	M4H	x	x	x	.ST043
5 steps, 1-pole				3	M4H	x	x	x	.ST051
5 steps, 2-pole				5	M4H	x	x	x	.ST052
6 steps, 1-pole				4	M4H	x	x	x	.ST061
7 steps, 1-pole				4	M4H	x	x	x	.ST071
8 steps, 1-pole				5	M4H	x	x	x	.ST081
9 steps, 1-pole				5	M4H	x	x	x	.ST091
10 steps, 1-pole				6	M4H	x	x	x	.ST0101

Ordering example: Multi step switch with 0, 10 steps, 1-pole, Central fixing without escutcheon plate: **M4H ZO ST0101**

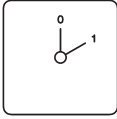
Load Switches for resistive or slightly inductive loads or switching without load

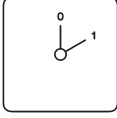
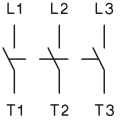
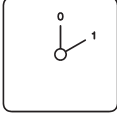
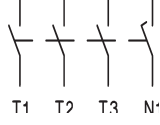
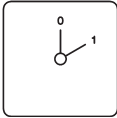
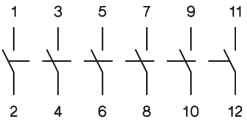
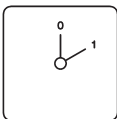
Description	Wiring diagram	Switching angle	Number of cells ↓ Size ↓ AC21	Type	Design		Switch program	Escutcheon plate
					.E.	.V.		
On-Off-switches A								
1-pole		60°	2 88 □ 125A	L100	x	x	. A1	
			1 180A					
			1 132 □ 400A	L400	x	x	. A1	
			3 600A	L600	x	x	. A1	
			2 800A	L800	x	x	. A1	
3 1200A	L1200	x	x	. A1				
2-pole		60°	2 88 □ 125A	L100	x	x	. A2	
			2 180A					
			2 132 □ 400A	L400	x	x	. A2	
			3 600A	L600	x	x	. A2	
			4 800A	L800	x	x	. A2	
			6 1200A	L1200	x	x	. A2	
3-pole		60°	4 88 □ 125A	L100	x	x	. A3	
			3 180A					
			3 132 □ 400A	L400	x	x	. A3	
			6 600A	L600	x	x	. A3	
			6 800A	L800	x	x	. A3	
			9 1200A	L1200	x	x	. A3	
4-pole 4. pole early make		60°	4 88 □ 125A	L100	x	x	. A4	
			4 180A					
			4 132 □ 400A	L400	x	x	. A4	
			6 600A	L600	x	x	. A4	
			8 800A	L800	x	x	. A4	
12 1200A	L1200	x	x	. A4				
6-pole		60°	6 88 □ 125A	L100	x	x	. A6	
			6 180A					
			6 132 □ 400A	L400	x	x	. A6	
			9 600A	L600	x	x	. A6	
			12 800A	L800	x	x	. A6	
			18 1200A	L1200	x	x	. A6	

For switches with the design V., it is necessary to state the installation depth - that is, the distance between mounting level of the switch and the inside edge of the door (dimension T).

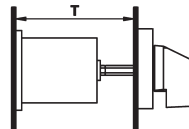

Further informations page
 Technical Data 261
 Dimensions 266

Load Switches for resistive or slightly inductive loads or switching without load

Description	Wiring diagram	Switching angle	Number of cells ↓ Size ↓ AC21	Type	Design .E. .V. ↓ ↓	Switch pro- gram	Escutcheon plate
Changeover switches U							
1-pole		60°	2 88 □ 125A	L100 .	x x	. U1	
			2 180A	L160 .	x x	. U1	
			2 132 □ 400A	L400 .	x x	. U1	
			3 600A	L600 .	x x	. U1	
			4 800A	L800 .	x x	. U1	
6 1200A	L1200 .	x x	. U1				
2-pole		60°	4 88 □ 125A	L100 .	x x	. U2	
			4 180A	L160 .	x x	. U2	
			4 132 □ 400A	L400 .	x x	. U2	
			6 600A	L600 .	x x	. U2	
			8 800A	L800 .	x x	. U2	
12 1200A	L1200 .	x x	. U2				
3-pole		60°	6 88 □ 125A	L100 .	x x	. U3	
			6 180A	L160 .	x x	. U3	
			6 132 □ 400A	L400 .	x x	. U3	
			9 600A	L600 .	x x	. U3	
			12 800A	L800 .	x x	. U3	
18 1200A	L1200 .	x x	. U3				
4-pole 4. pole early make		60°	8 88 □ 125A	L100 .	x x	. U4	
			8 180A	L160 .	x x	. U4	
			8 132 □ 400A	L400 .	x x	. U4	
			12 600A	L600 .	x x	. U4	
			16 800A	L800 .	x x	. U4	
24 1200A	L1200 .	x x	. U4				
Changeover switches without off W							
1-pole		60°	2 88 □ 125A	L100 .	x x	. W1	
			2 180A	L160 .	x x	. W1	
			2 132 □ 400A	L400 .	x x	. W1	
			3 600A	L600 .	x x	. W1	
			4 800A	L800 .	x x	. W1	
6 1200A	L1200 .	x x	. W1				
2-pole		60°	4 88 □ 125A	L100 .	x x	. W2	
			4 180A	L160 .	x x	. W2	
			4 132 □ 400A	L400 .	x x	. W2	
			6 600A	L600 .	x x	. W2	
			8 800A	L800 .	x x	. W2	
12 1200A	L1200 .	x x	. W2				
3-pole		60°	6 88 □ 125A	L100 .	x x	. W3	
			6 180A	L160 .	x x	. W3	
			6 132 □ 400A	L400 .	x x	. W3	
			9 600A	L600 .	x x	. W3	
			12 800A	L800 .	x x	. W3	
18 1200A	L1200 .	x x	. W3				
4-pole 4. pole early make		60°	8 88 □ 125A	L100 .	x x	. W4	
			8 180A	L160 .	x x	. W4	
			8 132 □ 400A	L400 .	x x	. W4	
			12 600A	L600 .	x x	. W4	
			16 800A	L800 .	x x	. W4	
24 1200A	L1200 .	x x	. W4				

Ordering example: AC1 1200A panel mounting, changeover switch without off 4-pole **L1200 E W4**

Operating Knobs and Handles

Types of handles

In the standard version, the switches are supplied with a black twist knob or instrument knob (M10H - N33F), except for design SMA, which has a grey toggle knob. Switches of size L, which consist of 2 or 3 switch columns, come with a black hand wheel. If required, the switch can be supplied with other knobs, which can later easily be exchanged. All operating knobs have an insert, which sets the position of the knob in relation to the switch shaft. This insert can be mounted in 8 different positions (at intervals of 45°), causing the angle of each individual switch setting to be rotated by 45°.

In the standard version, the switch terminals are positioned left and right (except M10H). When the knob insert is turned by 90°, the lay-out of the terminals changes to top and bottom.

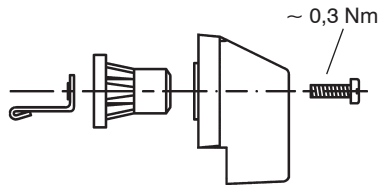

All operating knobs can be moved on the hexagonal shaft, to permit adaptation to different sheet thicknesses, etc.

Type	M10 M10H M20	N20 N33F	N40 N61 N80 L100 L160	N100 N200 L400 L600 L800 L1200
Knob movement mm	5	5	7	9
Hexagonal shaft dimension mm	5	7	9	12

Ordering example: Cam switch N61 V U3 with Instrument knob red
 Order type: **N61 V U3 +G3**
Dimensions see page 267



Knobs and handles Description	Colour	Ordering Code	M10 M10H M20	N20 N33F	N40 N61 N80 L100 L160	N100 N200 L400 L600 L800 L1200
Instrument knob Standard for M10 to N200	grey black red white	+G1 +G2 +G3 +G5	X X X X	X X X X	X	X
Toggle knob	grey black red white blue	+K1 +K2 +K3 +K5 +K6	X X X X X	X X X X		
Hand wheel	black	+HR				X

Escutcheon Plates

TELUX-Cam Switches in designs E, V, P, PF, SM, UP, Z and KE are supplied with a square escutcheon plate consisting of a black frame and plexi insert plate. The markings are printed in black on the back of the insert plate. To protect the markings so that they remain easy to read, the back of the insert plate is lined with silver foil. In addition, rectangular plates can be provided for all switch sizes, which can fitted on all switches after mounting.

Square plate

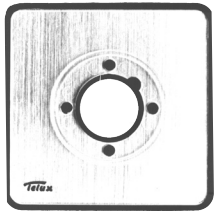

Rectangular plate
(with square plate)
Slot on the cover plate
upper side

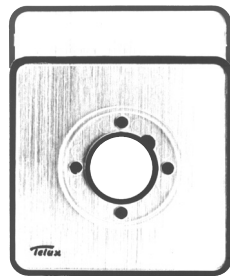

Preferred position of the slot
on bottom of
the cover plate

Slot for additional plate

TELUX-Cam Switches in design SMA, for distribution boards with 45mm inside edge of installation cover, is supplied with a grey cover and black markings.



Special engraved markings on escutcheon plates are limited by the available space. In the case of relatively large production runs or frequent use of the text, we recommend ordering of a printing block. This will be invoiced at cost price, and the engraving will not be charged for. This investment generally pays with batches from 50 pieces upwards.

The "escutcheon plate" column of the selection and ordering tables for switch programs indicates the standard plate and, in some cases, an additional plate that is often used for the programs in question. If such a plate, listed in the selection table, is desired, the appropriate code number should be stated when ordering a switch and switch program.

Should only **plates** or **parts** of the latter be ordered, the order type is assembled as shown by the following example.

Code letter of switch sizes

M10, M10H, M20	A
N20, N33F	E
N40, N61, N80, L100, L160	H
N100, N200, L400, L600, L800, L1200	L

Ordering example: Escutcheon plate silver, complete, for cam switch M10, marked with MAN OFF AUTO, angle of rotation 60°

Order type:

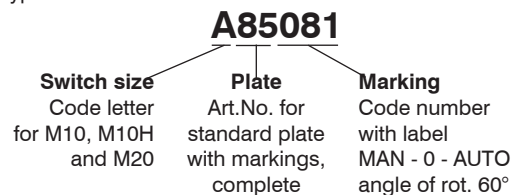

However, if a **switch** with non-standard lettering is required, only three-digit code number for the marking need be added to the order type (see next page).

Dimensions see page 267

Description	Order type Switch size Code letter	Plate Art.No.	Marking Code number
Escutcheon plate for designs E, V, P, Z, SM, KE and UP Escutcheon frame black, plexi insert plate silver, markings black			
Plexi insert plate silver	A E H L	.85...	... (see pp. 244-248)
Plexi insert plate yellow	A E H L	.80...	... (see pp. 244-248)
Escutcheon frame black	A E H L	.8203	-
Rectangular escutcheon plate for designs E, V, Z and SM Escutcheon frame black, plexi insert plate silver, markings black			
Plexi insert plate silver	A E H L	.885..	... (see pp. 244-248)
Plexi insert plate yellow	A E H L	.895..	... (see pp. 244-248)
Escutcheon frame black	A E H L	.8503	-
Installation cover for design SMA grey cover, markings black	A - - -	.69...	... (see page 246)

Escutcheon Plates

Selected standard markings

The markings that are most commonly required are shown below, together with code letters for the switch size and the code number.

Ordering example: Switch type M10H E A3 with escutcheon plate "OFF ON" and additional rectangular escutcheon plate "PUMP"

Order type: **M10H E A3 +003 +516**

Code letter of switch sizes

M10, M10H, M20
N20, N33F
N40, N61, N80, L100, L160
N100, N200, L400, L600, L800, L1200

A
E
H
L

Blank escutcheon plates

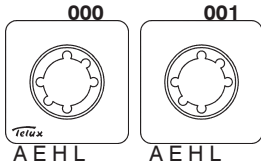

Switching angle 30°

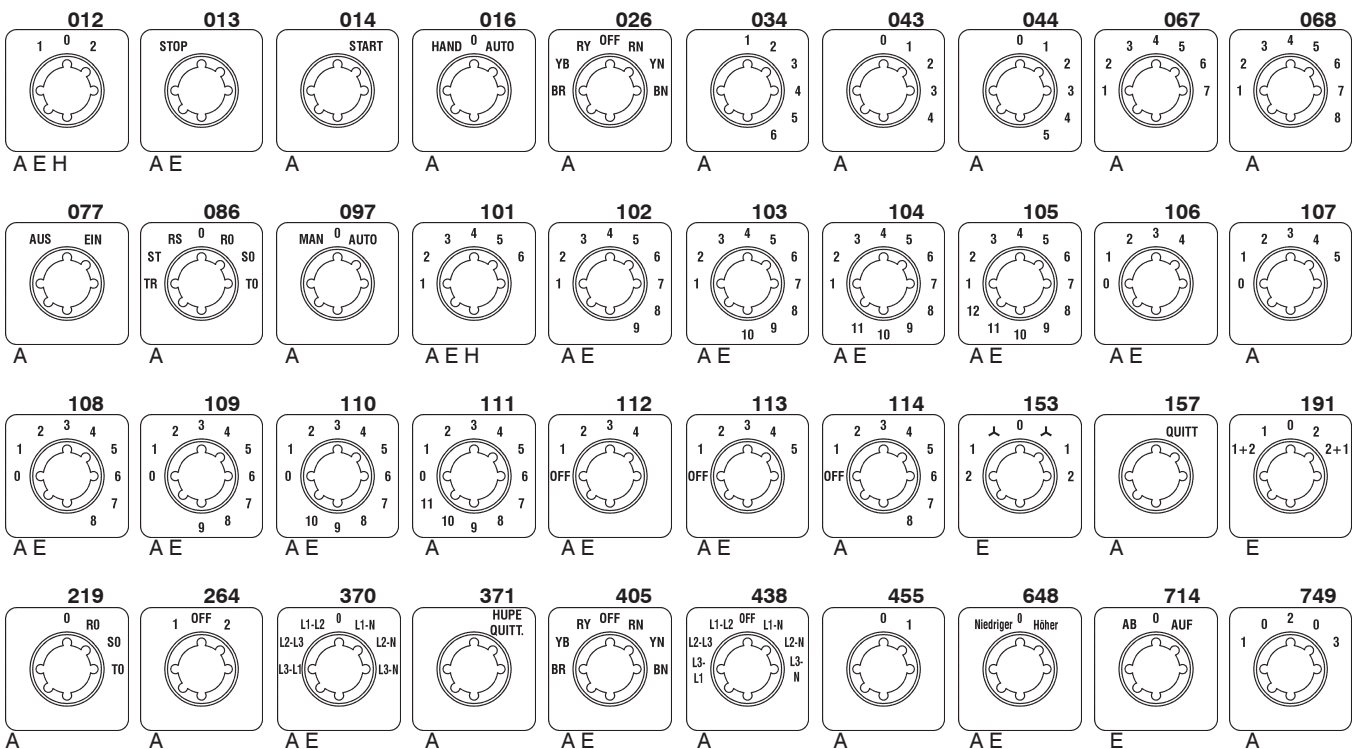

Switching angle 45°

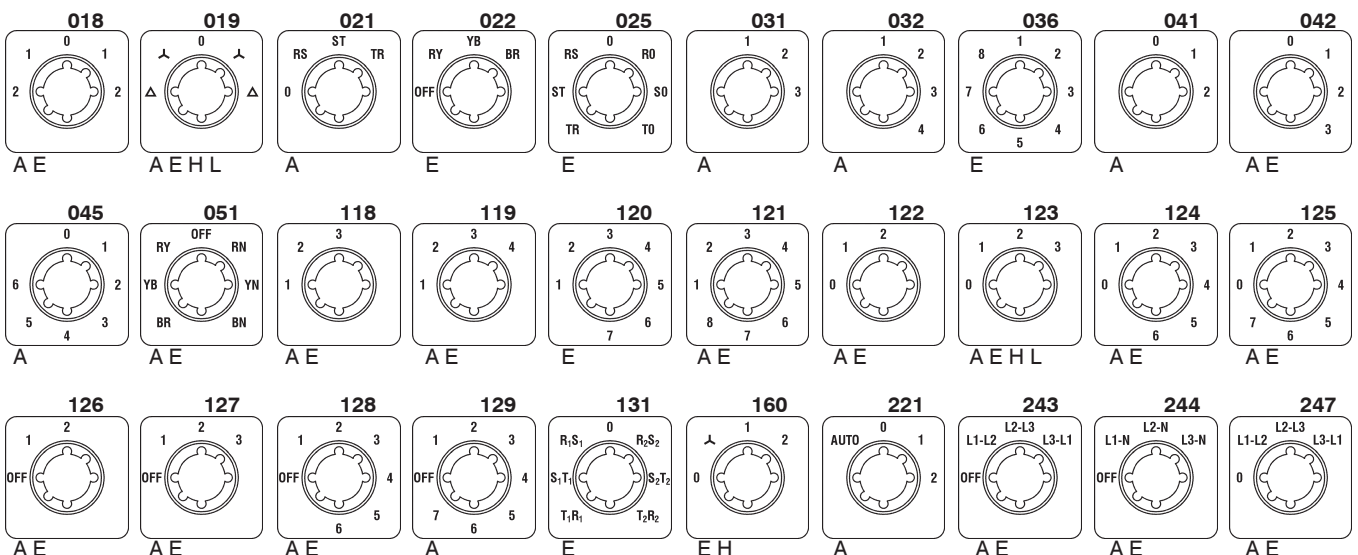

Escutcheon Plates

Switching angle 45°

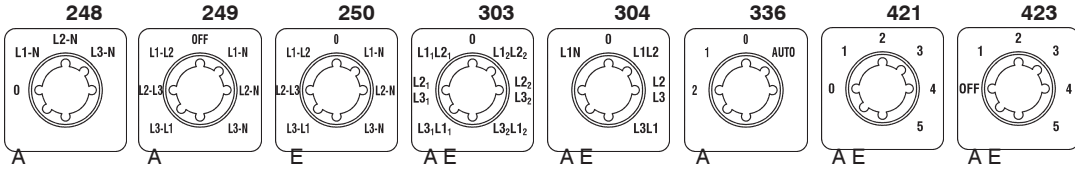

Switching angle 60°

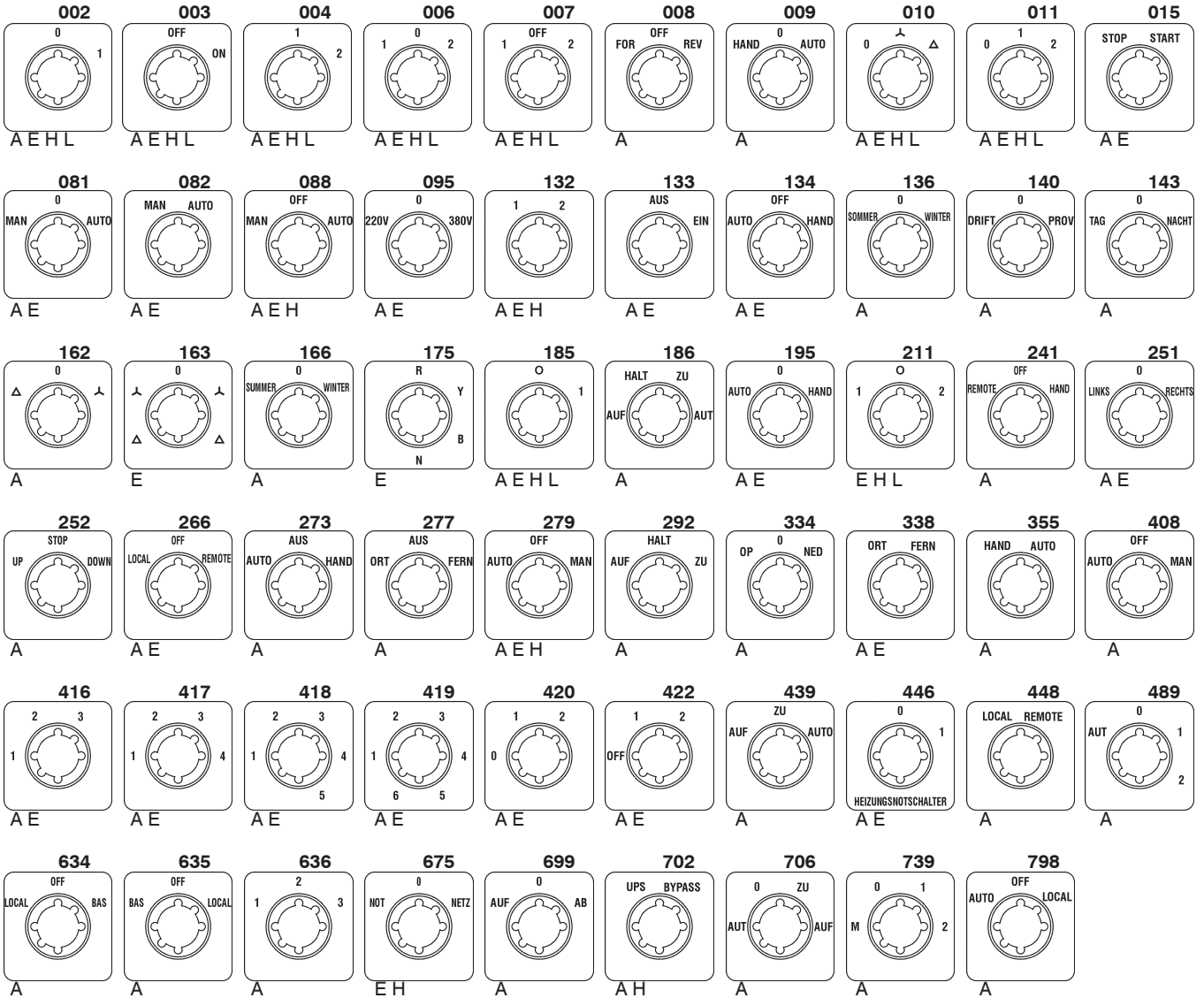

Escutcheon Plates

Switching angle 90°

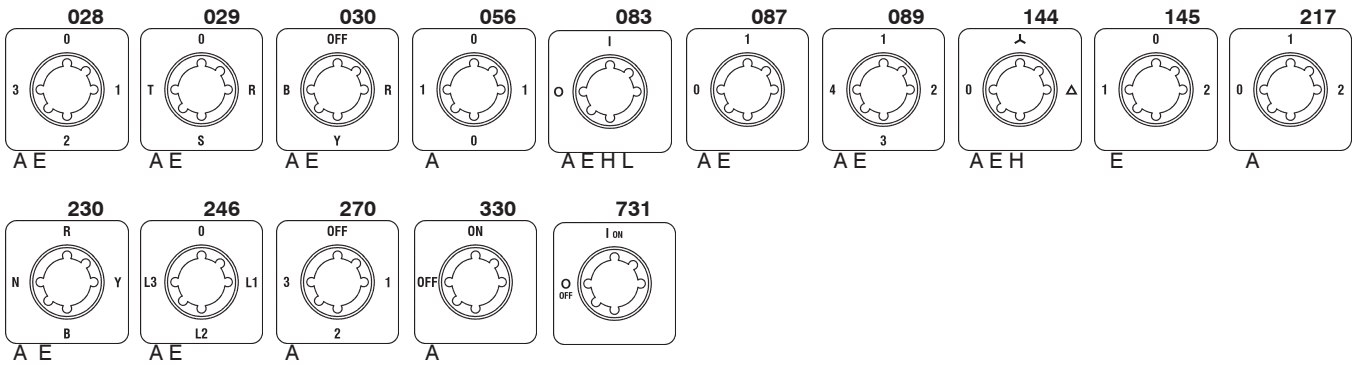

Miscellaneous

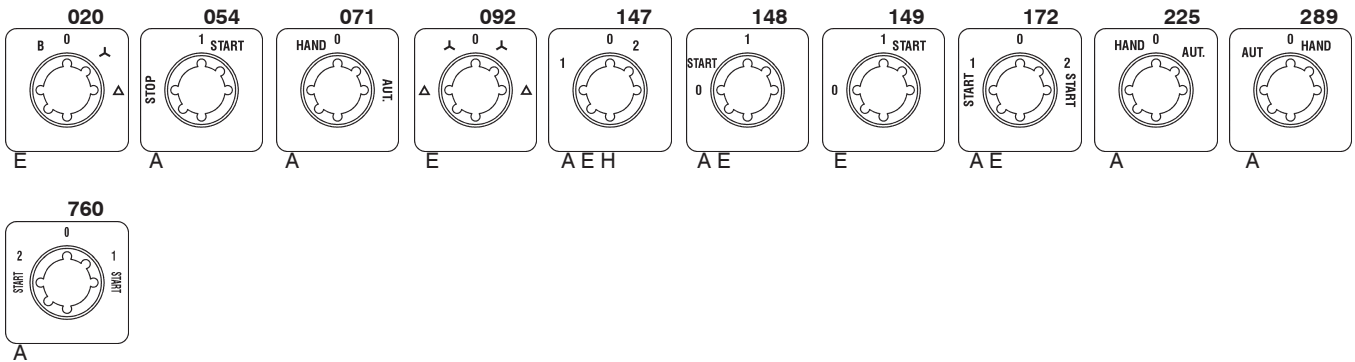

Rectangular additional escutcheon plates

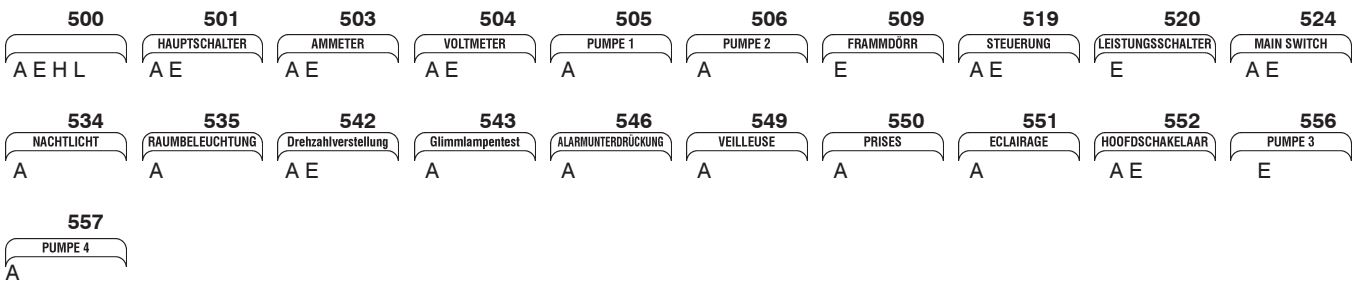

Covers for design SMA

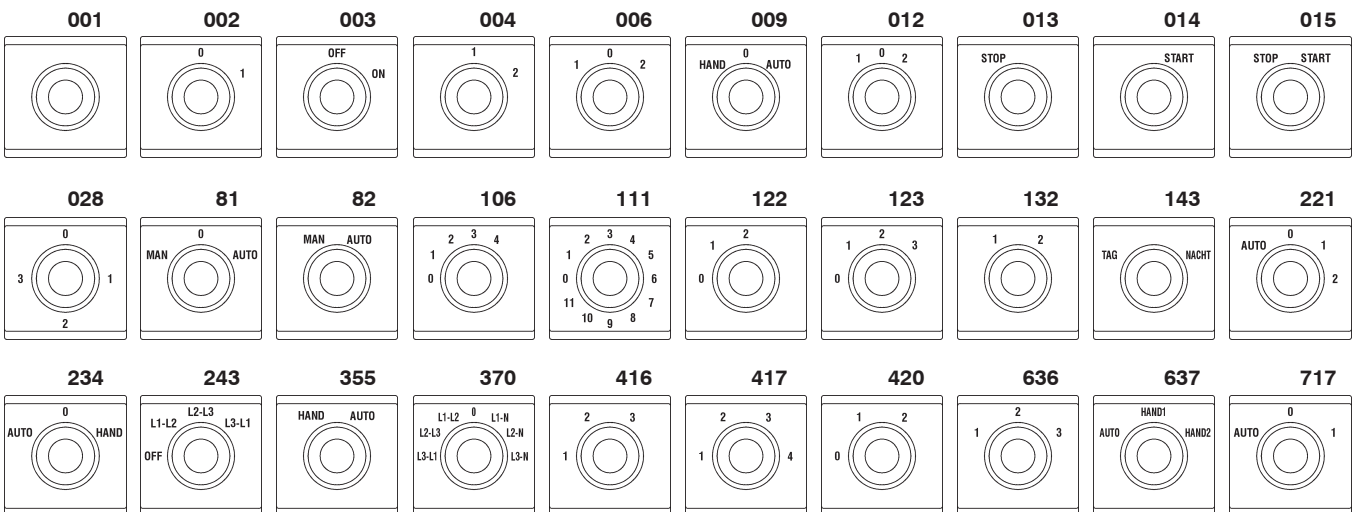

Switching angles

Arrangement of switch settings

All feasible arrangements of switch settings are shown, and defined by position numbers, in the following tables. Not only the switching angles, but also switches with latched or momentary settings, or combinations of the two, are distinguished from one another.

Knowledge of the following variations is particularly important when planning special switches. It is necessary to state the position number when ordering special switches, as the cheapest version will otherwise be selected.

All the switches types listed can be supplied with switching angles other than those indicated, provided that they are permitted by the switch program (additional charge).

Switching angle 30°

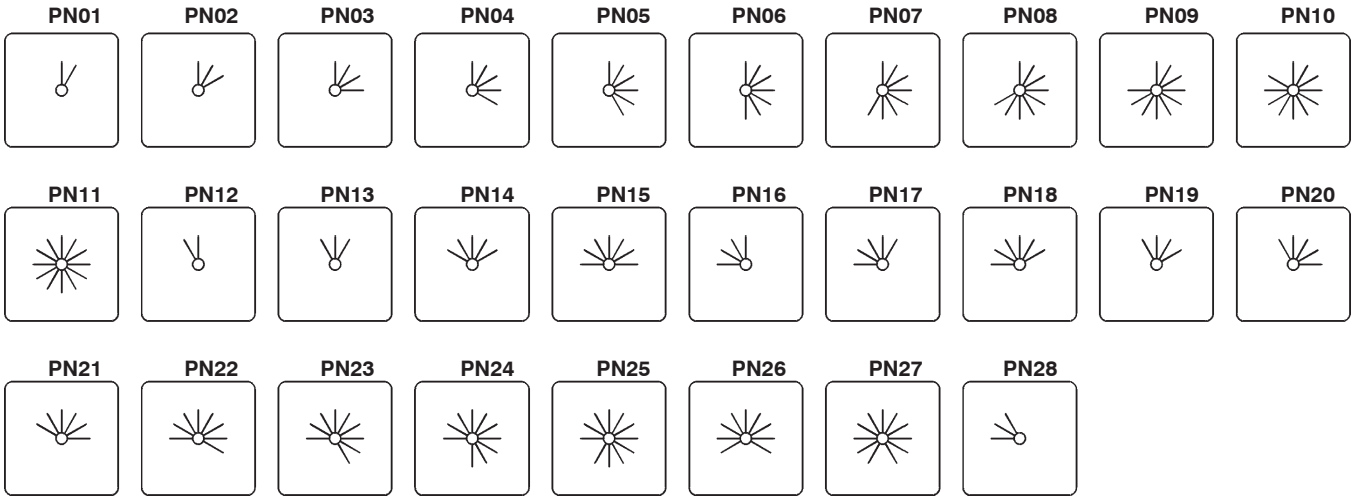

Switching angle 45°

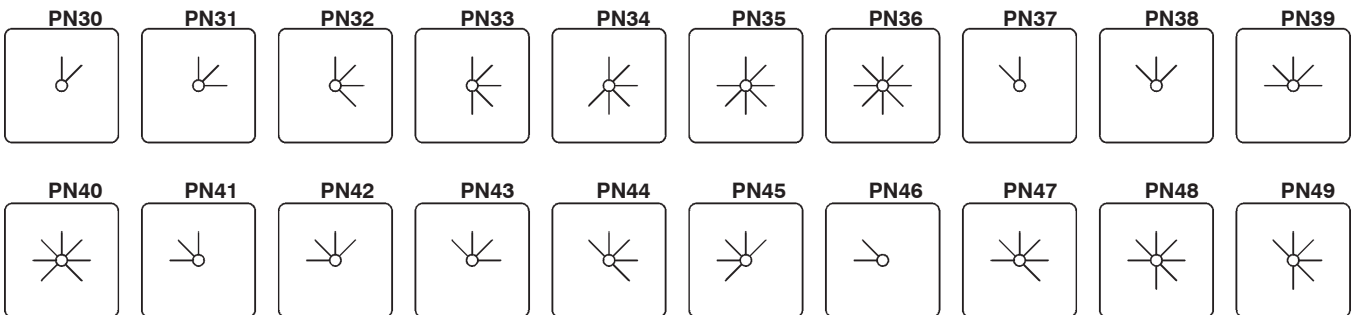

Switching angle 60°

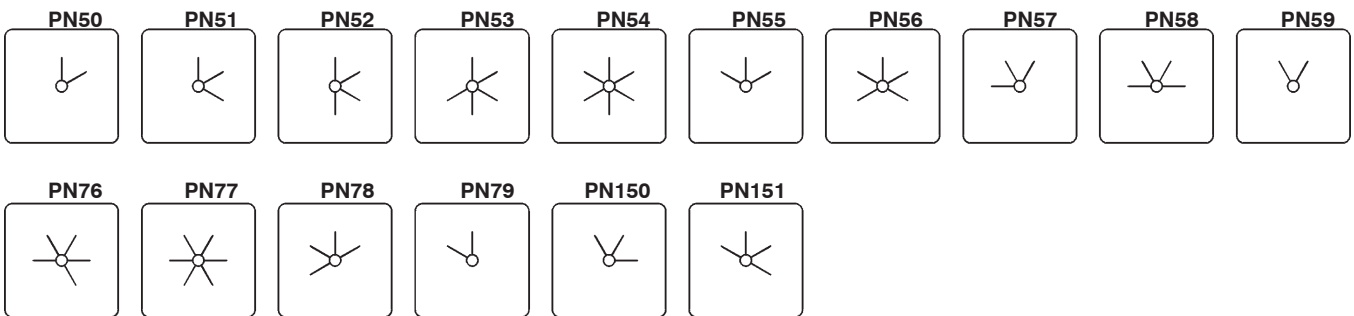

Switching angle 45/90°

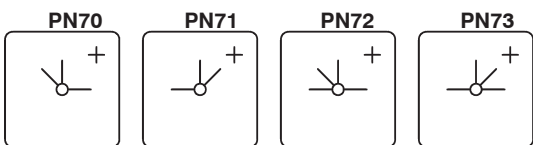

+) Not available for switch types M10, M10H and M20

Switching angles

Switching angle 90°

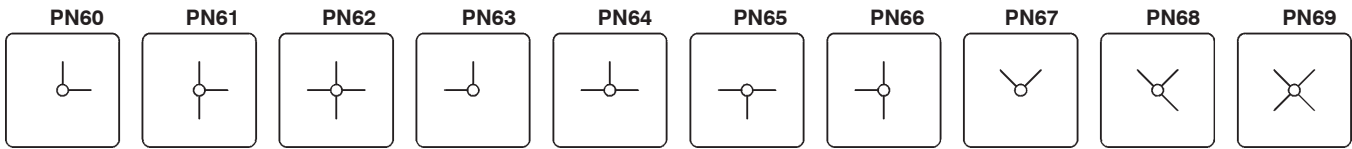

Momentary settings and special combinations

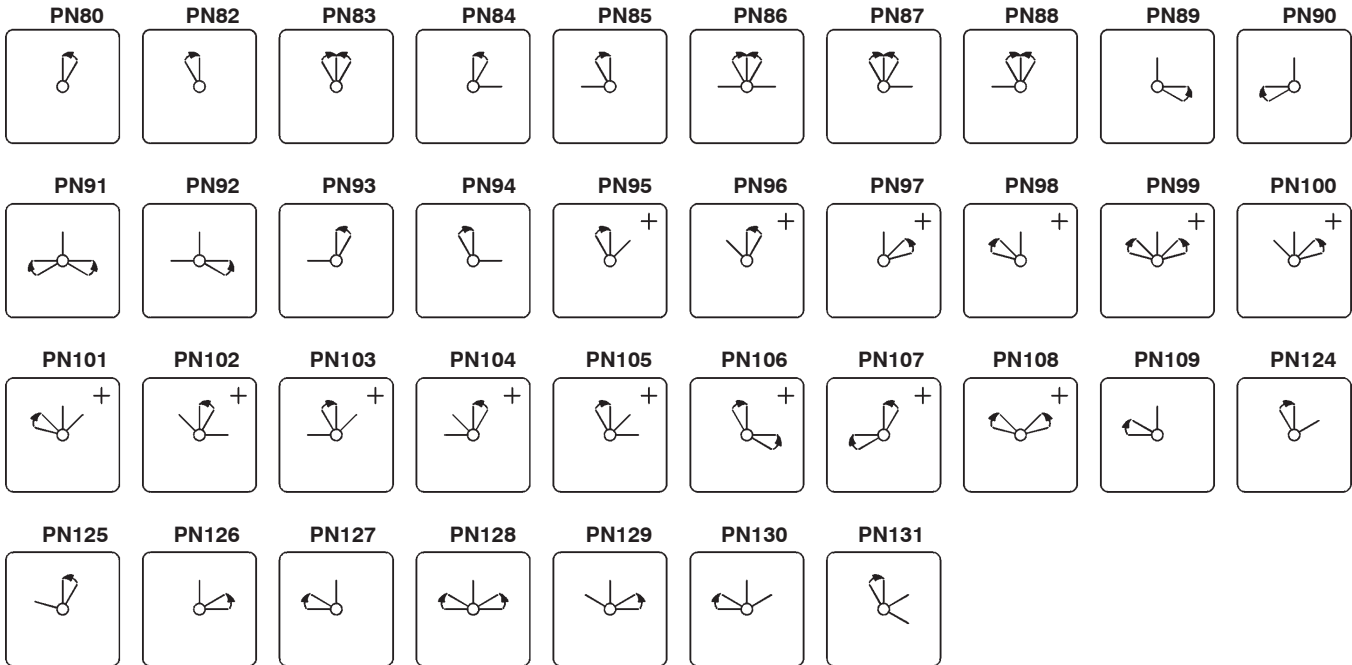

Spring return over several settings

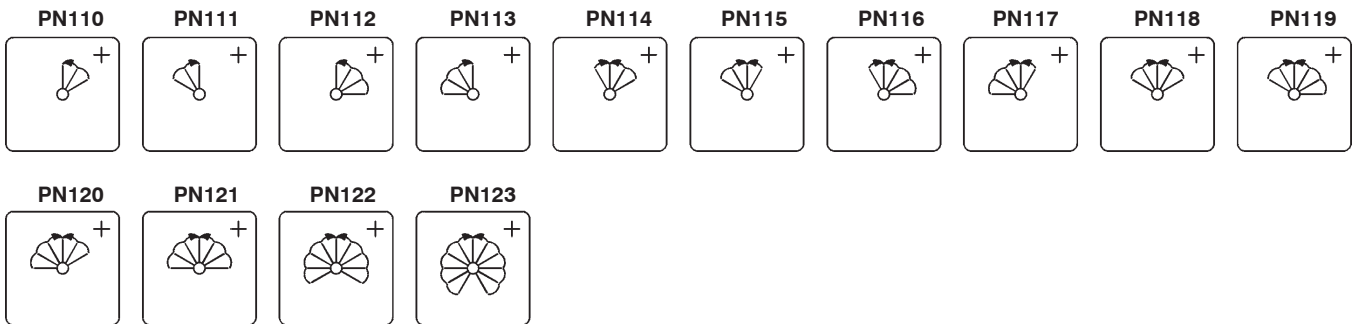

+) Not available for switch types M10, M10H and M20

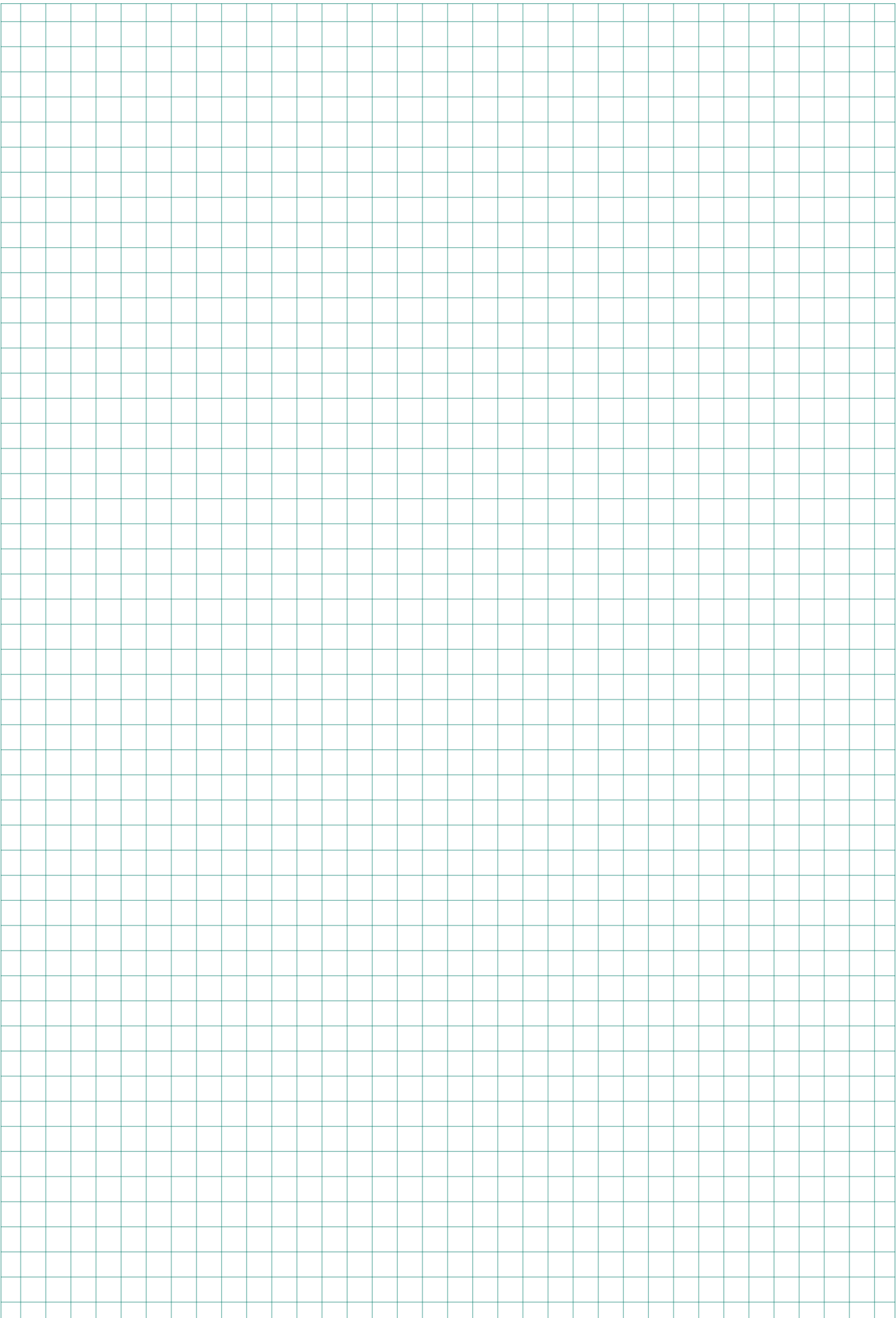

Contactors, Motor-Starter

Circuit Breakers

Manual Motor-Starters

Switches

AC-Main Switches

DC-Switch Disconnector

Push Buttons

Representatives, Suppliers

Door couplings

For switches with door couplings it is necessary to state the installation depth - that is, the distance between mounting level of the switch and the inside edge of the door (dimension T).

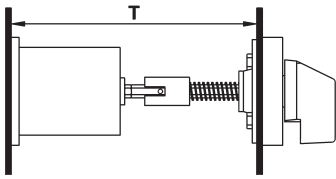

Door couplings are available for switches to be installed in switchgear cabinets or distribution boards with hinged doors. These permit the doors to be opened without removal of the operating knobs.

Ordering example: Cam switch N100 V A3 with lockable door coupling, moisture protected IP65, dimension T=580mm
Order type: **N100 V A3 +TK2FR/580**

Dimensions see page 269



	Ordering Code	Suitable for designs	Suitable for switch type
Door coupling Protection class from front: IP65 5-hole mounting	+TKE/...	V, SM	M10H, M20, N20, N33F
Door coupling locked Protection class from front: IP65 5-hole mounting Doors only open at a given switch setting: unless otherwise stated, the "OFF" setting.	+TK2E/...	V, SM	M10H, M20, N20, N33F
Door coupling locked Protection class from front: IP65 Central fixing Ø22mm Doors only open at a given switch setting: unless otherwise stated, the "OFF" setting.	+TK2Z/...	V, SM	M10H, M20, N20, N33F
Door coupling Protection class from front: IP40 5-hole mounting	+TK/...	V	N40, N61, N80, N100, N200 L100, L160, L400, L600 L800
Door coupling Protection class from front: IP54 5-hole mounting	+TKFR/...	V	N40, N60, N80, N100, N200 L100, L160, L400, L600 L800
Door coupling locked Protection class from front: IP40 5-hole mounting Doors only open at a given switch setting: unless otherwise stated, the "OFF" setting.	+TK2/...	V	N40, N61, N80, N100, N200 L100, L160, L400, L600 L800
Door coupling locked Protection class from front: IP54 5-hole mounting Doors only open at a given switch setting: unless otherwise stated, the "OFF" setting.	+TK2FR/...	V	N40, N61, N80, N100, N200 L100, L160, L400, L600 L800

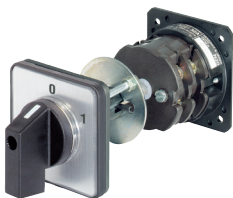
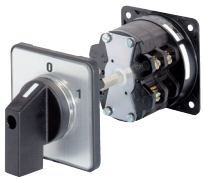

Lockable switches

Key-operated and lockable switches are supplied with two keys. Additional keys or other types of lock on request.

Ordering example: Cam switch N20 E A3 key operated
Order type: **N20 E A3 +SA**

Dimensions see page 270 and 271



Key operated switch
Lock Willenhal FT101, key removable in all lockable settings.
Other types of lock on request.
Maximum number of cells
M10 - N33F: 6 N40, N61: 2
Key operated switch, key removable only in some settings. Add letter of setting where key is removable to ordering code according to the scetch below.

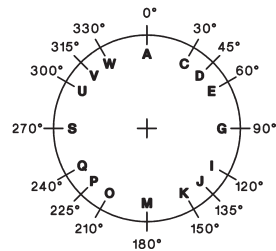

Key operated switch IP65
Lock Ronis R455, key removable in all lockable settings.
Key operated switch, key removable only in some settings. Add letter of setting where key is removable to ordering code according to the scetch above.

Key operated switch
Lock KABA8, key removable in all lockable settings.
Key operated switch, key removable only in some settings. Add letter of setting where key is removable to ordering code according the scetch below.

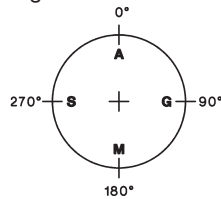

Ordering Code	Suitable for designs	Suitable for switch type
+SA +SA/.	E, V, SM E, V P SMA UP	M10H, M20 N20, N33F M10, N20, N33F M10H, M20 M10
+SA +SA/.	Z, ZO	M10H, M20
+SAK +SAK/.	E	M10H, M20



Padlock devices

A range of padlock devices designed to prevent from being turned on by unauthorized personnel, or during maintenance and repair work, can be supplied.

Dimensions see page 272

Ordering example: Cam switch N33F E A3 with interlocking device SV3 suitable for 3 padlocks

Order type: **N33F E A3 +SV3**

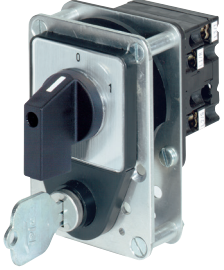
	escut. plate [mm]	Ordering Code	Suitable for designs	Suitable for switch type
	48x48	+SV1 +SV1R	E, V, SM P, PF	M10H, M20 M10
	64x64	+SV164 +SV164R	E, V P, PF	M10H, N20, N33F N20, N33F
	88x88	+SV3 +SV3R	E, V E, V E, V PF	N40, N61, N80 N100, N200, L400, L600, L800, L1200 N40, N61, N80
	132x132	+SV3 +SV3R	E, V E, V E, V PF	N40, N61, N80 N100, N200, L400, L600, L800, L1200 N40, N61, N80
	64x64	+SV4 +SV4R	E, V SM P, PF	M10H, N20, N33F M10H, N20, N33F N20, N33F
	88x88	+SV488 +SV488R	E, V E, V P, PF	N20, N33F N40, N61, N80 N40, N61, N80
		+SZ	E, V SM	all M10H, M20, N20, N33F
		+SZ2	E, V SM	all M10H, M20, N20, N33F

Switch interlocks

A wide range of locks and interlocking devices, designed to prevent accidental or hazardous switching, can be supplied.

Ordering example: Cam switch N20 E A3 with push button switch lock
Order type: **N20 E A3 +DV**

Dimensions see page 273

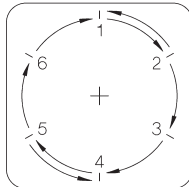
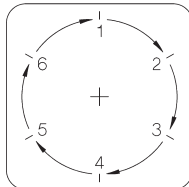
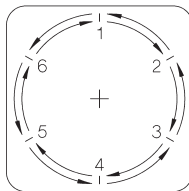

Description	Ordering Code	Suitable for designs	Suitable for switch type
Push button interlock The switch can only be actuated when the pushbutton is simultaneously depressed (two-handed operation).	+DV	E, V	all
Interlock with electrical contact The switch can only be actuated when the pushbutton, which also operates a make and break contact, is actuated (for external interlocking devices or safety measures).	+ET	E, V	all
Magnetic interlock The switch can only be actuated when an electromagnet is simultaneously excited. When ordering, voltage and percentage duty cycle of the magnet coil should be stated.	+MV	E	N20, N33F, N40, N61, N80, N100, N200
Circular switch Switches that have the maximum number of settings for a given switching angle can be made without a stop position, permitting direct switching from the last to the first setting.	+RU	all	all
Backswitch 1 Special version of the circular switch, in which the switch can only be turned in one direction.	+RS1	all	all
Backswitch 2 Special version of the circular switch, in which, in given positions, the switch can only be operated in one direction.	+RS2	all	all

Couplings and stop mechanism

A range of couplings and stop mechanisms for trouble-free operation of switches with a very large number of contacts can be supplied.

Dimension see page 274

Ordering example: Cam switch N200 V ST0113 spread over three columns interconnected by gears

Order type: **N200 V ST0113 +ZK3**



Description	Ordering Code	Suitable for designs	Suitable for switch type
<p>Coupling of different switch sizes For attachment of control switches (auxiliary contacts) to larger switches. M10H, M20 in sizes E and H. N20 to N80 in size L.</p>	+ZWK	E	N40, N61, N80, L100, L160 N100, N200, L400, L600, L800, L1200
<p>Second stop mechanism With switches in which a large number of contacts is simultaneously operated, use of a second stop mechanism is sometimes necessary, in order to ensure precise switching to the next setting.</p>	+RW2	all	all

Special versions

A number of special versions can be supplied for adaptation of switches to various conditions of use.

Ordering example: Cam switch M10H E U3 with large front plate
Order type: **M10H E U3 +GFP**

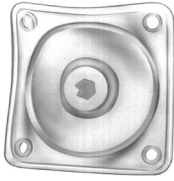

Description	Ordering Code	Suitable for designs	Suitable for switch type
Switch shaft sealing For increased front protection class on IP54.	+WD	E, V SM	N20 to L1200 N20, N33F
Front plate/switch shaft sealing For increased front protection class on IP65. In this version, a wider hole is required for the shaft. Dimensions see page 272	+FPWD	E, V, SM	N20, N33F
Extended switch shaft For adaptation of switch designs V and SM to the enclosure depth. State additional shaft length when ordering.	+VW/...	E, V SM	all M10H, M20, N20, N33F
Large front plate Switch with front plate and operating knob of the next size (for replacement of older, larger switches or aesthetic reasons).	+GFP	E, V, SM	M10H, N20, N33F
Neon safety switch For all-pole switching off of neon advertisement circuits by the Fire Brigade. Dimensions see page 274	+FEU	E	N20, N33F

Accessories

A number of special versions can be supplied for adaptation of switches to various conditions of use.

Dimensions see page 273

Ordering example: Cam switch N20 E A3 with terminal cover plate
Order type: **N20 E A3 +KLAD**

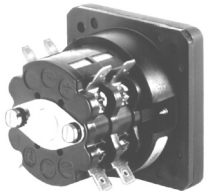
Description	Ordering Code	Suitable for designs	Suitable for switch type
Terminal cover plate Prevents accidental touching of live terminals (requirement for main switches according to VDE 0113) only for 2 cells for all cells	+KLAD	E, V	N20, N40, N61, N80 N100, N200
	+KLAD	E, V	N33F
Moisture proofing caps Protection class from rear: IP54. For protection of the switch from dust and moisture (e.g. when installed in machine pedestals). For switch mounting from the front and rear. Conical cable entry glands. Maximum number of cells: M10H 7 N20 5 N40 4 N61 2	+FR	E	M10H, N20, N40, N61
 Angled terminals For easy connection of inaccessible switches. Unless otherwise stated, all terminals specified with markings are equipped in this manner. A distinction is drawn between left and right angled terminals. Seen from the switch end, the left terminals are located above left and below right; conversely, right terminals are above right and below left.	+WK	E, V	M20, N20, N40, N61, N80, N100
 Fast-on connectors For 6,3 x 0,8mm plugs.	+AMPZ	E, V	M20, N20
Earth terminals 2 terminals, connected with one another, insulated from switch column: for earth conductors.	+PE	E, V, P, PF PF G, GF	all M10, N20, N33F, N40, N61 N80 N20
Additional rectangular escutcheon plate 1 line Dimensions see page 267	SRE	E, Z, V, SM	all
Big additional rectangular escutcheon plate for 2 lines Dimensions see page 267	SRE2	E, V	M10H, M20, N20, N33F
Spare key for key operated switches with Lock Willenhal FT101	J7101	E, V, P SMA	M10H, M20, N20, N33F, N40 M10H, M20
Spare key for key operated switches with Lock Ronis R455	B4-R455	Z, ZO	M10H, M20
Wrench for switches with central fixing	J7049	Z, ZO	M10H, M20

Switching Programs according to Customer Requirements

As a result of their modular construction, TELUX cam switches are particularly suitable for manufacturing of special variants. According to its function, each pair of contacts in the switch is adapted to the desired program by appropriate design of the cam plate. In the case of switches with an overall switching angle of more than 180°, provision must be made for a cam plate in each switching cell, controlling two opposite, independent contact pairs with matching programs (does not apply to M10, M10H, M20 and N20).

Depending on the desired contact program for the special switch, it may often be impossible to make full use of all switching cells, that is, to include the maximum possible number of contacts. In determining the number of cells or switch length, one-contact cells will sometimes be resorted to.

Switch sizes M10, M10H, M20 and N20 are exceptions to this rule. Here, two cam plates can be built into each cell, so that both contacts are independently controlled (full use of the cells with special programs).

In all special switches with overall switching angles of less than 180°, the number of cells required is calculated by having the total number of contacts in the switching program.

When planning for switches with special programs, choice of the optimum switching angle thus plays an important part. The listing of all the options for lay-out of switch settings, on pages 247 and 248, should be an aid to planning (position numbers PN).

If special markings are to be engraved on the escutcheon plates, it is vital to take account of the available space. It is advisable to use abbreviations.

We provide forms (see page 275) on request, free of charge, to give a clear overview when special programs are being defined. Switch size, design, type of operating knob and desired switching angle, as well as the function of the contacts, are entered on these forms. Provision has also been made in them for entry of details as to escutcheon plate engravings or other special requirements.

Ordering Example

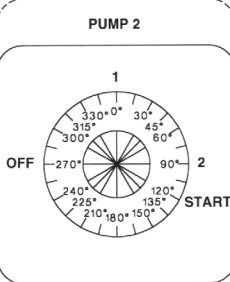
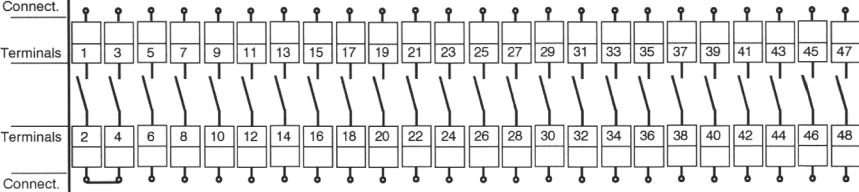
Order sheet D399E		Cam switches with special switching program		Customer:	
Switch Type		Benedict GmbH			
M4H		A-1220 Vienna, Liebgasse 7			
M10		Phone: 251 51-0 Fax: 251 51-88			
M10H	<input checked="" type="checkbox"/>	Explanations:		Handles	
M10HD		Contact closed over <input checked="" type="checkbox"/>		Twist knob R (standard) black (standard) <input checked="" type="checkbox"/>	
M20		several positions <input checked="" type="checkbox"/>		Instrument knob G (standard M4H) <input checked="" type="checkbox"/>	
N20		Spring return from pos. <input type="checkbox"/>		Toggle knob K (standard SMA) grey (standard SMA)	
N33F				Pointer knob Z white	
N40	L400			Ball type handle B cream-coloured	
N61	L600			Lever handle H yellow	
N80	L800			Hand wheel HR blue	
N100	L1200				
N200					
Design					
Panel mounting E		Marking for switch position		Degree	
Central fixing Z	<input checked="" type="checkbox"/>	OFF		270	
Base mounting V		1		0	
Snap-on mount.SMA		2		45	
Plastic enclosure P		START		90	
IP65	PF			120	
Optional extras					
Circular switch					
Key removeable <input checked="" type="checkbox"/>					

Order sheet A4 see page 275

Utilization Categories

For easier choice of devices and in order to make the comparison of different products simpler are utilization categories for cam switches according to IEC 947-3, VDE 0660 Part 107 and

auxiliary contacts according to IEC 947-5-1 and VDE 0660 Part 200 determined. The Table below offers diverse utilization categories and assorted test conditions.

Kind of current	Category		Typical applications	Rated operational current	Test conditions for the number of on-load operating cycles (normal service)						Test conditions for making and breaking capacities (operation in fault case)					
	fre-quent operation	infre-quent operation			Make			Break			Make			Break		
					I/l _e	U/U _e	cosφ	I _c /l _e	U _r /U _e	cosφ	I/l _e	U/U _e	cosφ	I _c /l _e	U _r /U _e	cosφ
Alternating Current	AC20A	AC20B	No-load conditions	all values	-	-	-	-	-	-	-	-	-	-	-	-
	AC21A	AC21B	Switching of resistive loads including moderate overloads	all values	1	1	0,95	1	1	0,95	1,5	1,05	0,95	1,5	1,05	0,95
	AC22A	AC22B	Switching of mixed resistive and inductive loads including moderate overloads	all values	1	1	0,8	1	1	0,8	3	1,05	0,65	3	1,05	0,65
	AC23A	AC23B	Switching of motor loads or other highly inductive loads	0 < I _e ≤ 100A all values 100A < I _e	1	1	0,65	1	1	0,65	10	1,05	0,45	8	1,05	0,45
	AC2		Slip-ring motors: Starting, plugging	all values	2,5	1	0,65	2,5	1	0,65	4	1,05	0,65	4	1,05	0,65
	AC3		Squirrel-cage motors: Starting, switching off motors during running	0 < I _e ≤ 100A all values 100A < I _e	I _e ≤ 17A 6 1 I _e > 17A	0,65	I _e ≤ 17A 1 0,17 I _e > 17A	0,65	10	1,05	0,45	8	1,05	0,35	0,45	0,35
	AC4		Squirrel-cage motors: Starting, plugging, inching	0 < I _e ≤ 100A all values 100A < I _e	I _e ≤ 17A 6 1 I _e > 17A	0,65	I _e ≤ 17A 6 1 I _e > 17A	0,65	12	1,05	0,35	10	1,05	0,35	0,45	0,35
	AC15		Control of electromagnetic loads (> 72VA)	-	10	1	0,7	1	1	0,4	10	1,1	0,3	10	1,1	0,3
					I/l _e	U/U _e	L/R ¹⁾	I _c /l _e	U _r /U _e	L/R ¹⁾	I/l _e	U/U _e	L/R ¹⁾	I _c /l _e	U _r /U _e	L/R ¹⁾
Direct current	DC20A	DC20B	No-load conditions	all values	-	-	-	-	-	-	-	-	-	-	-	-
	DC21A	DC21B	Switching of resistive loads including moderate overloads	all values	1	1	1	1	1	1	1,5	1,05	1	1,5	1,05	1
	DC22A	DC22B	Switching of mixed resistive a. induct. loads incl. moderate overloads (shunt motors)	all values	1	1	2	1	1	2	4	1,05	2,5	4	1,05	2,5
	DC23A	DC23B	Switching of highly inductive loads (e.g. series motors)	all values	1	1	7,5	1	1	7,5	4	1,05	15	4	1,05	15
	DC3		Shunt-motors: Starting, plugging, inching	all values	2,5	1	2	2,5	1	2	4	1,05	2,5	4	1,05	2,5
	DC5		Series-motors: Starting, plugging, inching	all values	2,5	1	7,5	2,5	1	7,5	4	1,05	15	4	1,05	15

U_e Rated operational voltage, U Voltage before make, U_r Recovery voltage, I_e Rated operational current, I Current made, I_c Current broken
1) Time in milliseconds (ms)

Note:
By plugging, is understood stopping or reversing the motor rapidly by reversing motor primary connections while the motor is running.
By inching (jogging), is understood energizing a motor once or repeatedly for short periods to obtain small movements of the driven mechanism.

Technical Data

Data according to IEC 947-3, IEC 947-5-1, VDE 0660, EN 60947-3, EN 60947-5-1

Type	M10 P	M10H	M10HD	M20	N20	N33F	N40	N61	N80	N100	N200
Rated therm. current I_{th} open A	20	20	10	32	32	50	63	90	115	150	250
Rated therm. current I_{the} encl. A	20	20	10	32	32	50	63	90	115	150	250
Rated operational voltage U_e V	440	690 ¹⁾	690 ¹⁾	690 ¹⁾	690 ¹⁾	690 ¹⁾	690 ¹⁾	690 ¹⁾	690 ¹⁾	690 ¹⁾	690 ¹⁾
Disconnection property ²⁾ acc. to VDE, IEC up to V	440	440	- ⁴⁾	440	440	440	690	440	440	690	690
Breaking capacity I_{eff}											
3 x 220-440V A	160	160	35	220	220	260	380	520	740	900	1100
3 x 500V A	-	100	-	160	160	200	290	380	560	680	850
3 x 660-690V A	-	80	-	120	120	150	200	290	520	450	-
Utilization categ. AC21A, AC21B Switching of resistive loads including moderate overloads											
Rated operational current I_e A	20	20	10	32	32	50	63	90	115	150	250
Utilization categ. AC23A, AC23B Switching of motor loads or other highly inductive loads											
Rated current I_e 400V A	16	16	3,5	30	30	45	45	60	85	105	135
Power rating 220-240V kW	4	4	0,75	7,5	7,5	11	15	22	30	40	40
3-phase 3-pole 380-440V kW	7,5	7,5	1,5	15	15	22	22	30	45	55	70
500V kW	-	7,5	1,5	15	15	22	22	30	45	55	70
660-690V kW	-	7,5	1,5	15	15	22	18,5	30	45	45	-
Star-Delta-Switches for squirrel cage motors											
Power rating 3-phase 3-pole 220-240V kW	3,7	3,7	-	7,5	7,5	8	11	15	18,5	37	40
380-415V kW	7,5	7,5	-	15	15	18,5	18,5	25	30	40	70
Utilization category AC3 Switching of three-phase motors											
Rated current I_e 400V A	12	12	2	22	22	30	30	50	60	80	135
Power rating 220-240V kW	3	3	0,37	5,5	5,5	7,5	7,5	15	18,5	25	40
3-phase 3-pole 380-440V kW	5,5	5,5	0,75	11	11	15	15	25	30	40	70
500V kW	-	5,5	0,75	11	11	15	15	25	30	40	70
660-690V kW	-	5,5	0,75	11	11	15	15	25	30	40	70
Utilization category AC4 squirrel cage motors, inching											
Power rating 220-240V kW	0,55	0,55	-	2,2	2,2	3,7	4	5,5	6	11	18,5
3-phase 3-pole 380-440V kW	1,5	1,5	-	4	4	5,5	7,5	11	15	18,5	35
500V kW	-	1,5	-	4	4	5,5	7,5	11	15	22	35
660-690V kW	-	1,5	-	4	4	5,5	7,5	11	15	22	-
Utilization category AC15 Control of electromagnetic loads, contactors,											
Rated current I_e up to 240V A	6	6	2,5	12	12	16	-	-	-	-	-
380 - 440V A	4	4	1,5	6	6	7	-	-	-	-	-
2-pole in series 500V A	-	5	-	8	8	10	-	-	-	-	-
Utilization categ. DC21A, DC21B Switching of resistive loads											
Time constant $L/R \leq 1ms$											
Rated current I_e 1-pole 30V A	20	20	10	32	32	40	63	80	100	150	250
60V A	4	4	-	6	6	20	30	30	30	-	-
110V A	0,6	0,6	-	3	3	4	6	6	6	-	-
220V A	0,5	0,5	-	0,8	0,8	0,8	1,3	1,3	1,3	2,5	2,5
440V A	-	-	-	0,4	0,4	0,4	0,6	0,6	0,6	0,7	0,7
Utilization category DC3 - DC5 Switching of shunt motors and series motors											
Time constant $L/R \leq 15ms$											
Rated current I_e 1-pole 30V A	8	8	-	13	13	16	25	32	40	60	100
60V A	1	1	-	2,4	2,4	4	12	12	12	-	-
110V A	0,3	0,3	-	0,5	0,5	1,6	2,4	2,4	2,4	-	-
Protection class of terminals ¹⁾	IP00	IP20	IP20	IP00	IP00	IP20	IP00	IP00	IP00	IP00	IP00

1) suitable for: earthed-neutral systems, overvoltage category I to III, pollution degree 3 (standard-industry): $U_{imp} = 6kV$. Data for other conditions on request

2) valid for lines with grounded common neutral termination, overvoltage category III, pollution degree 3.

3) Protection degree of the terminals with connected insulated conductor. Additional protection with terminal cover (KLAD).

4) Fulfil the requirements acc. to load switches.

Technical Data

Data according to IEC 947-3, IEC 947-5-1, VDE 0660, EN 60947-3, EN 60947-5-1

Type		M10 P	M10H	M10HD	M20	N20	N33F	N40	N61	N80	N100	N200
Cable cross-sections												
solid	mm ²	1-2,5	1-2,5 ¹⁾	1-2,5 ¹⁾	1,5-6	1,5-6	2,5-10	2,5-16 ¹⁾	6-25 ¹⁾	6-35	10-50 ¹⁾	50-150
flexible	mm ²	0,75-2,5	0,75-2,5 ¹⁾	0,75-2,5 ¹⁾	1-4	1-4	1,5- 6	2,5-10 ¹⁾	6-25 ¹⁾	6-35	10-35 ¹⁾	35-120
flexible w. multicore cable end	mm ²	0,75-2,5	0,75-1,5	0,75-1,5	1-4	1-4	1,5- 6	2,5-6	6-16	6-35	10-25	-
Conductors to clamp per pole		2	2	2	2	2	2	2	1	1	1	1
Size of terminal screw		M3	M3,5	M3,5	M4	M4	M4	M5	2xM5	2xM5	2xM6	M10
Tightening torque	Nm lb.inch	0,6-1,2 5-11	0,8-1,4 7-12	0,8-1,4 7-12	1,2-1,8 11-16	1,2-1,8 11-16	1,2-1,8 11-16	2,5-3 22-26	2,5-3 22-26	2,5-3 22-26	3,5-4,5 31-40	23 202
Short circuit protection												
Max. fuse size	gL (gG) A	20	20	20	35	35	50	63	100	125	160	250
Rated short-time withstand current (1sec. current)	A	250	250	-	400	400	500	800	1000	1400	1800	3000
Rated conditional short-circuit current	kA _{eff}	10	10	1	10	10	10	10	10	10	10	10
Short-time capacity												
Load duration	3s A	100	100	-	200	200	350	400	600	720	1000	2000
	10s A	60	60	-	130	130	230	250	400	480	600	1200
Note: Ratings applies to contacts already closed	30s A	35	35	-	85	85	110	160	250	300	500	600
	60s A	25	25	-	65	65	80	110	200	250	370	480
Power loss at AC21A												
per pole	A W	20 0,6	20 0,5	10 0,5	32 0,9	32 1,1	50 1,9	63 2	85 2,8	115 4,4	150 5,7	250 21
Switching of capacitive loads												
maximum making capacity up to 500V	A	140	140	-	300	300	350	400	600	700	900	1800

Data according to UL and cUL

Type		M10 P	M10H	M10HD	M20	N20	N33F	N61	N80	N100	N200	L400
Rated voltage	V~	300	600	600	600	600	600	600	600	600	600	600
Rated operational current "General Use" with jumper	A A	20 15	20 -	5 -	35 25	35 25	60 40	90 80	115/125 ³⁾ 80/125 ³⁾	130 -	250 -	350 -
DOL-Rating 3-phase	110-120V hp 200-208V hp 220-240V hp	1½ 2 3	1½ 2 3	- - -	5 5 5	5 5 5	7½ 10 15	8½ 12½ 17	10 15 20	15 25 30	15 25 30	15 25 30
	440-480V hp 550-600V hp	- -	5 7½	- -	10 15	10 15	25 30	35 40	40 50	40 50	60 75	60 75
DOL-Rating 1-phase	110-120V hp 200-208V hp 220-240V hp	½ 1 1½	½ 1 1½	- - -	1½ 3 5	1½ 3 5	3 5 7½	4 6½ 8	5 7½ 10	7½ 15 15	7½ 15 20	7½ 15 20
Fuse size (RK5) Man. Motor Controller 5kA / 600V and Motor Disconnect	A	40 ²⁾	40	-	80	80	150	150	200	300	350	350
Heavy pilot duty	AC	A300	A600	B600	A600	A600	A600	A600	A600	A600	A600	A600
Cable cross sections												
solid	AWG	12 - 20	12 - 20	12 - 20	10 - 18	10 - 18	10 - 12	10 - 12	10 - 12	10 - 14	-	-
flexible	AWG	14 - 20	14 - 20	14 - 20	8 - 18	8 - 18	6 - 12	2 - 12	2/1 ³⁾ - 12	1 - 14	250kcmil	500kcmil
Tightening torque	Nm lb.inch	1-1.2 9-11	1-1.4 9-13	1-1.4 9-13	1.7-1.8 15-16	1.7-1.8 15-16	1.2-1.8 11-16	2.8 25	2.8 25	4.5 40	23 202	40 352

1) Maximum cable cross-section with prepared conductor

2) 5kA / 300V

3) Increased rated operational current 125A "General Use" and "with jumper" with AWG 1. Add suffix + WK.

Technical Data

Data according to IEC 947-3, IEC 947-5-1, VDE 0660, EN 60947-3, EN 60947-5-1

Type		L100	L160	L400	L600	L800	L1200
Rated insulation voltage U_i	V	690 ²⁾	690 ²⁾	690 ²⁾	690 ²⁾	690 ²⁾	690 ²⁾
Rated thermal current I_{th} openA	125	180	400	600	800	1200	
Rated thermal current I_{the} encl. A	125	180	400	600	800	1200	
with conductor	mm ²	50	70	busbar 40x5	busbar 40x10	busbar 2x40x10	busbar 2x50x10
Utilization category AC21A, AC21B							
Switching of resistive loads, including moderate overloads							
Rated operational current I_o	A	125	180	400	400	400	400
Shot-time current-carrying capacity							
Load duration	1s	-	-	4800	6500	8500	10000
	3s	800	1200	3600	5000	6500	8000
	10s	500	800	2000	3200	4000	5800
Note: Ratings applies to contacts already closed	30s	320	480	1200	1700	2200	3200
	60s	180	380	960	1300	1700	2300
Cable cross-sections							
solid or stranded	mm ²	25-50 ¹⁾	cable lug	busbar	busbar	busbar	busbar
flexible	mm ²	25-50 ¹⁾	70	40x5	40x10	2x40x10	2x50x10
flexible with multicore cable end	mm ²	25-35	-	-	-	-	-
Number of conductors to clamp per pole		1	1	1	2	1	1
Size of terminal screw		2xM5	M8	M12	M16	M16	M16
Tightening torque	Nm	3	12	40	98	98	98
	lb.inch	26	105	352	862	862	862
Short circuit protection							
Max. fuse size	slow, gL (gG) A	125	200	400	630	800	1250

1) Maximum cable cross-section with prepared conductor

2) suitable for: earthed-neutral systems, overvoltage category I to III, pollution degree 3 (standard-industry): $U_{imp} = 6kV$.
Data for other conditions on request

Mechanical Life

Schwitch type		M10, M10H	M20, N20, N33F	N40, N60, N80	N100, N200
Operations	x10 ³	300	250	200	150

Note: The minimum mechanical and electrical life is defined according to IEC/EN60946-3 (approx. 10.000 operations).

Dimensions (mm)

Panel mounting E M10 - N100

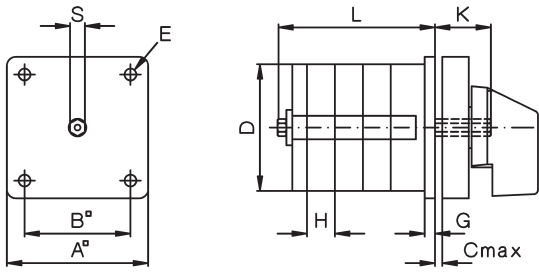

N200

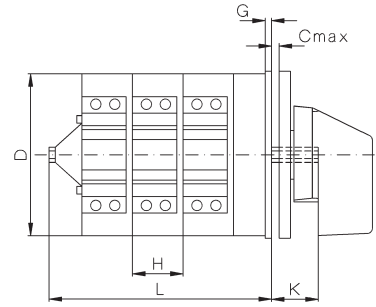
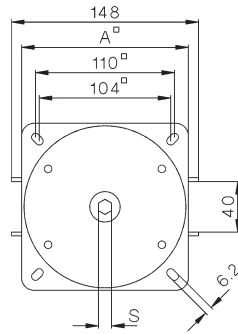

Type	A	B	C	D	D1	D2	D3	E	G	H	K	S
M10H	48	36	5	44 ¹⁾	5	8	-	4	3,5	9,5	19	SW5
M20	48	36	5	56	5	8	-	4	3,5	12,5	19	SW5
N20	64	48	5	56	5	12	57	4,2	3	12,5	20	SW7
N33F	64	48	5	58 ²⁾	5	12	-	4,2	3	15,5	20	SW7
N40	86	68	7	80	6	12	82	5,2	3,5	18	24,5	SW9
N61	86	68	7	80	6	12	82	5,2	3,5	29,5	24,5	SW9
N80	86	68	7	80	6	12	82	5,2	3,5	29,5	24,5	SW9
N100	132	110	9	128	7	16	129	6,2	5	30	37	SW12
N200	132	110	9	128	7	16	-	6,2	5	40	37	SW12

1) 44,5 x 42

2) 58 x 58

Mounting holes: built in from rear
Mounting screw: J3631N M=1,2-1,4 Nm

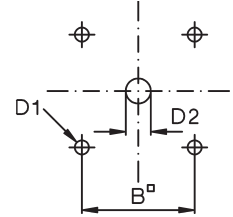

Mounting holes: built in from front

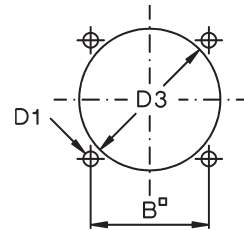

Type	Dimension L with .. cells														
	1	2	3	4	5	6	7	8	9	10	11	12	13	14	15
M10H	36,5	46	55,5	65	74,5	84	93,5	103	112,5	122	131,5	141	-	-	-
M20	38,5	51	63,5	76	88,5	101	113,5	126	138,5	151	163,5	176	-	-	-
N20	40,5	53	65,5	78	90,5	103	115,5	128	140,5	153	165,5	178	190,5	203	215,5
N33F	44	59,5	75	90,5	106	121,5	137	152,5	168	183,5	199	214,5	230	245,5	261
N40	52,5	70,5	88,5	106,5	124,5	142,5	160,5	178,5	196,5	214,5	232,5	250,5	268,5	286,5	304,5
N61	64	93,5	123	152,5	182	211,5	241	270,5	300	329,5	359	388,5	-	-	-
N80	64	93,5	123	152,5	182	211,5	241	270,5	300	329,5	359	388,5	-	-	-
N100	88	118	148	178	208	238	268	298	328	358	388	418	-	-	-
N200	96	136	176	216	256	296	336	376	416	456	496	536	-	-	-

Central fixing Z M10H, M20, N33F

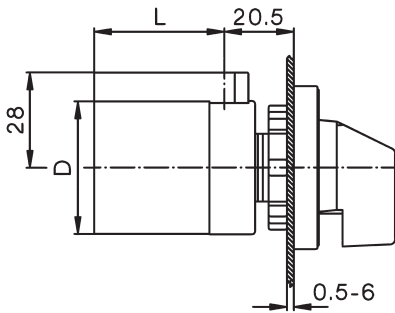

Central fixing without escutcheon plate ZO M10H, M20

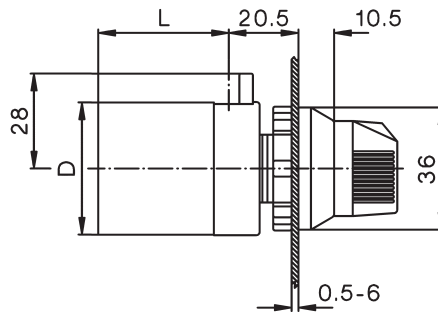

Mounting hole:

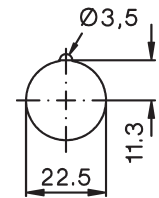

Further dimensions see tables above

Mini-Cam Switches M4H

Panel mounting E

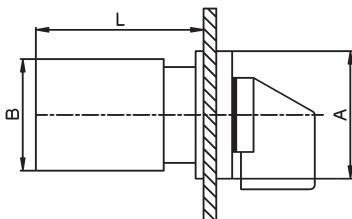

Central fixing Z, ZO

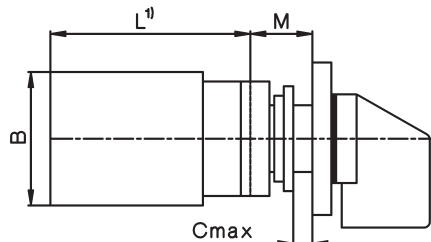

ZO

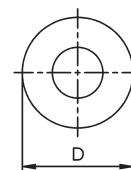

Z

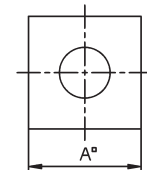

Typ	mm	Dimension L with .. cells											
		A	B	D	M	1	2	3	4	5	6	7	8
M4H		30	28	29,5	12,5	38,5	50,5	62,5	74,5	86,5	98,5	110,5	122,5

Mounting holes see page 236

Dimensions (mm)

Flush mounting UP M10

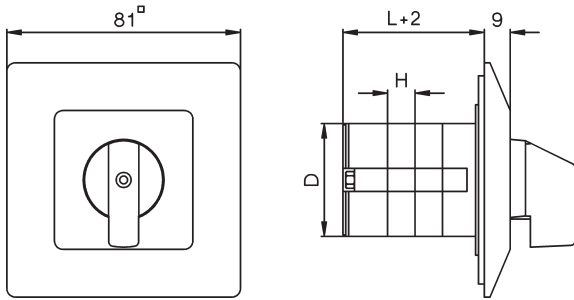

Base mounting V M10H - N100

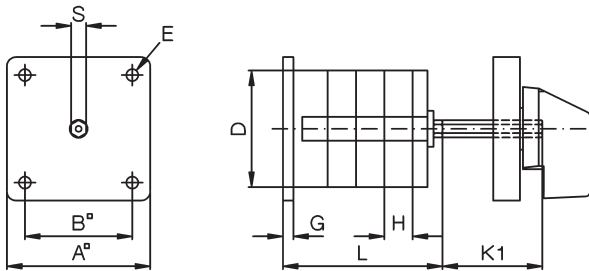

N200

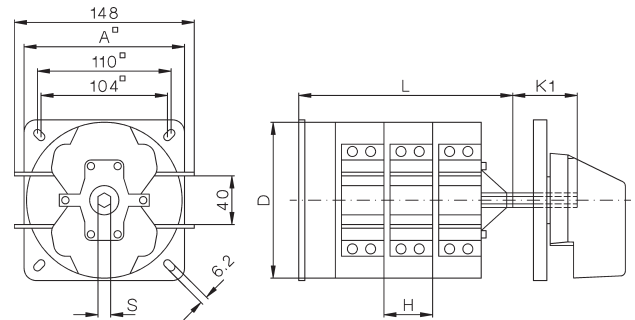

Type	A	B	D	D1	D2	E	G	H	I	K	K1	
M10	48	36	39	5	8	4	3,5	9,5	6	19	41	SW5
M10H	48	36	44 ¹⁾	5	8	4,2	3	9,5	6	19	41	SW5
M20	48	36	56	5	8	4,2	3	12,5	6	19	47	SW5
N20	64	48	56	5	12	4,2	3	12,5	0	20	29	SW7
N33F	64	48	58 ²⁾	5	12	4,2	3	15,5	0	20	31,5	SW7
N40	86	68	80	6	12	5,2	3,5	18	-	-	38,5	SW9
N61	86	68	80	6	12	5,2	3,5	29,5	-	-	49,5	SW9
N80	86	68	80	6	12	5,2	3,5	29,5	-	-	49,5	SW9
N100	132	110	128	7	16	6,2	5	30	-	-	79,5	SW12
N200	132	110	128	7	16	6,2	5	40	-	-	104	SW12

Mounting holes: for escutcheon plate

1) 42 x 44,5

2) 58 x 58

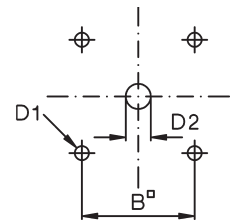

Type	Dimensions L with ... cells														
	1	2	3	4	5	6	7	8	9	10	11	12	13	14	15
M10	34,5	44	53,5	63	72,5	82	91,5	101	110,5	120	129,5	139	-	-	-
M10H	36,5	46	55,5	65	74,5	84	93,5	103	112,5	122	131,5	141	-	-	-
M20	38,5	51	63,5	76	88,5	101	113,5	126	138,5	151	163,5	176	-	-	-
N20	40,5	53	65,5	78	90,5	103	115,5	128	140,5	153	165,5	178	190,5	203	215,5
N33F	44	59,5	75	90,5	106	121,5	137	152,5	168	183,5	199	214,5	230	245,5	261
N40	52,5	70,5	88,5	106,5	124,5	142,5	160,5	178,5	196,5	214,5	232,5	250,5	268,5	286,5	304,5
N61	64	93,5	123	152,5	182	211,5	241	270,5	300	329,5	359	388,5	-	-	-
N80	64	93,5	123	152,5	182	211,5	241	270,5	300	329,5	359	388,5	-	-	-
N100	88	118	148	178	208	238	268	298	328	358	388	418	-	-	-
N200	96	136	176	216	256	296	336	376	416	456	496	536	-	-	-

Snap-on mounting SM

M10H - N33F for 35mm DIN-rail mounting according to DIN EN 50022

Dimensions see tables above

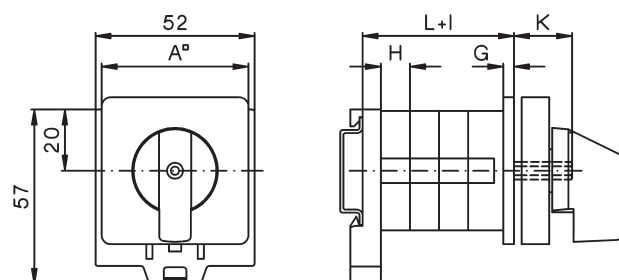

Switch with installation cover SMA

M10H, M20 for 35mm DIN-rail mounting according to DIN EN 50022

Type	Dimension X with ... cells						Dimension Y with ... cells					
	1, 2	3	4	5	6		1, 2	3	4	5	6	
M10H	44	44	72,5	72,5	72,5		60	60	88,5	88,5	88,5	
M20	44	61	76	76	76		60	75	90	90	90	

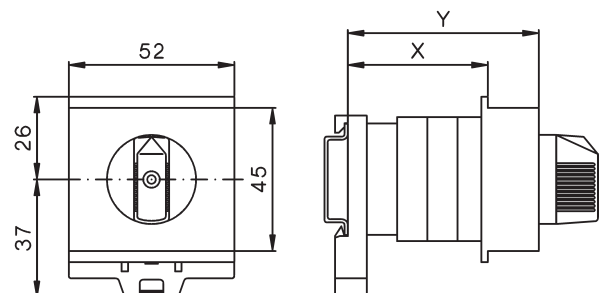

Dimensions (mm)

Plastic enclosed switches P, PF M10 - N61

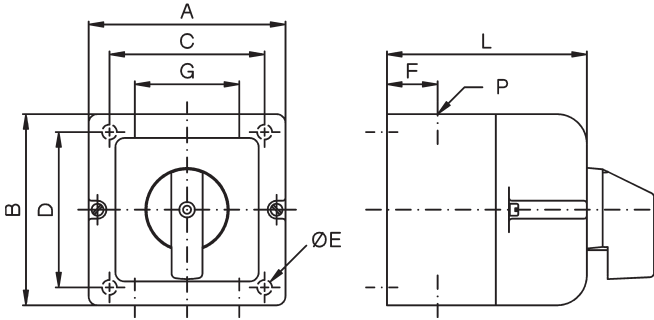

N61, N80

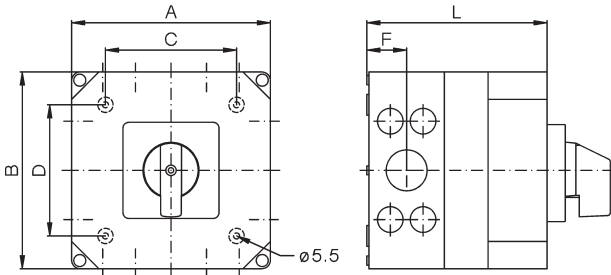

Type	A	B	C	D	E	F	G	P	Dimension L with .. cells					
									1	2	3	4	5	6
M10	66	64	50	36	5	15,5	26	M20	43	52	62	71	81	90
N20	82	78	57	53	4,5	17	29	M20	66	66	80	94	108	122
N33F	112	108	85	50	5	20	50	M25	92	92	110	128	146	164
N40	112	108	85	50	5	20	50	M25	92	92	110	128	146	164
N61	112	108	85	50	5	20	50	M25	92	110	-	-	-	-
N61	182	180	120	120	5,5	36,5	-	1)	-	-	165	215	215	-
N80	182	180	120	120	5,5	36,5	-	1)	110	110	165	215	215	-

1) Knock outs for M40/M32 + 4x M20 at top and bottom M32/M25 + 4x M20 at the right and left hand side.

Motor terminal box mounting KE M10 - N33F

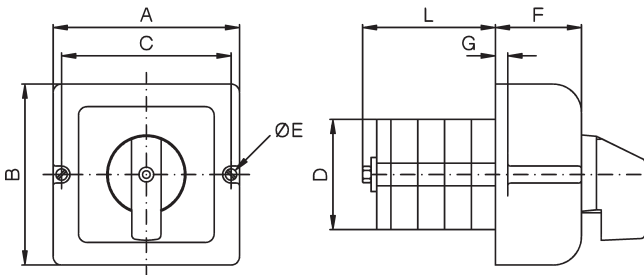

Mounting holes

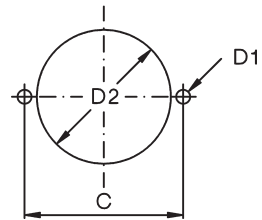

Type	A	B	C	D	D1	D2	E	F	G	Dimension L with .. cells					
										2	3	4	5	6	
M10	66	64	58	39	4	48	3,2	24	6	22	31,5	41	50,5	60	
N20	82	78	71	48	5	57	4,2	34	5	24,5	37	49,5	62	74,5	
N33F	112	108	100	56	5	70	4,2	49	11	32,5	48	63,5	79	94,5	

Plastic enclosed motor starter PM N20

Typ	P	Dimension L with .. cells					
		1	2	3	4	5	6
N20	M25	80	80	80	92,5	105	117,5

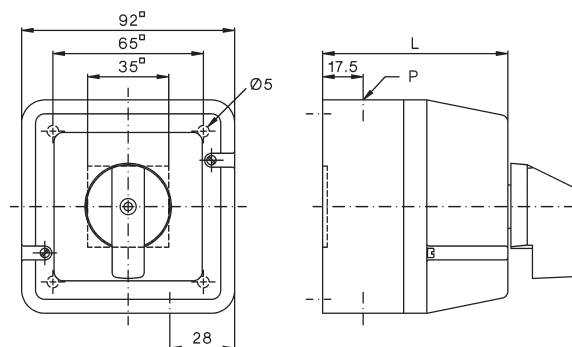

Dimensions (mm)

Plastic enclosure horizontal PLF (Replacement for cast aluminium enclosure G, GF)
N40, N61, N80

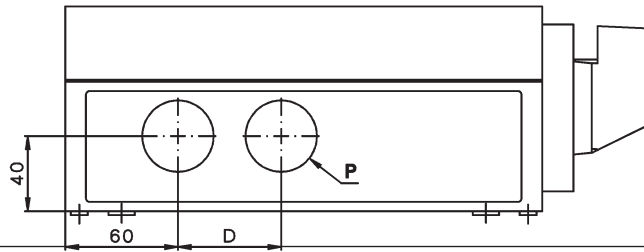
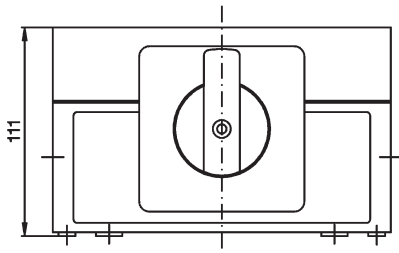

Type	N40 1 - 6 cells N61 1 - 3 cells N80 1 - 3 cells	N40 7 - 10 cells N61 4 - 6 cells N80 4 - 6 cells
A	182	254
B	167	239
C	120	190
D	-	65
P	2 x Ø40,5 (M40)	4 x Ø40,5 (M40)

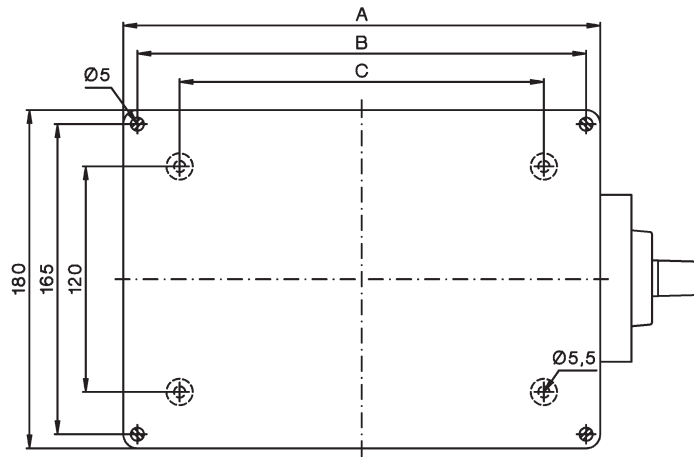

Dimensions (mm)

Load Switches

Panel mounting E

L100 - 400, L800, L1200

L600

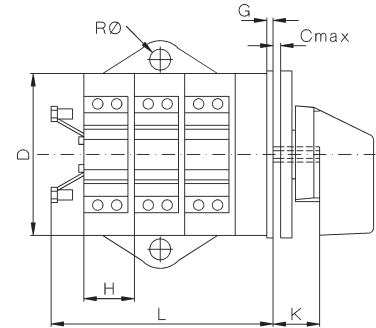
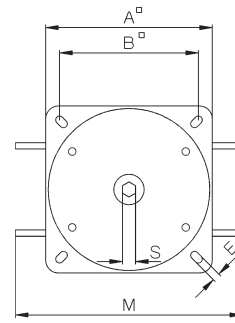
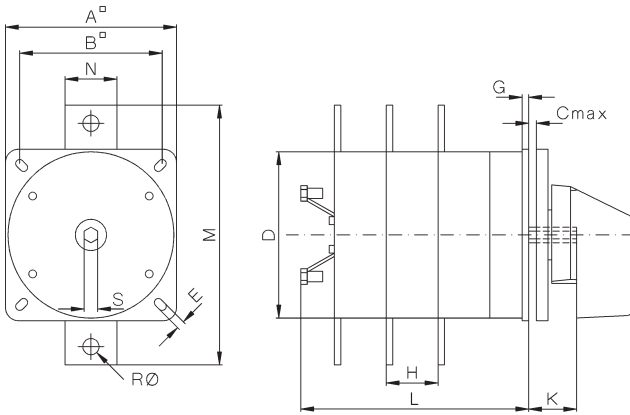

Base mounting V

L100 - 400, L800, L1200

L600

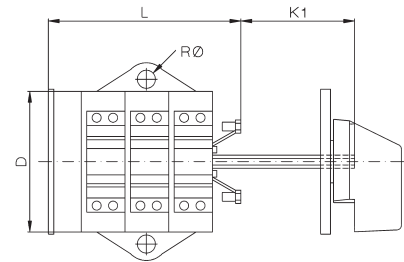
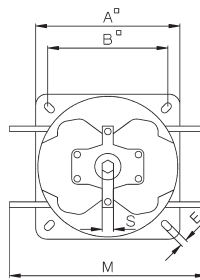
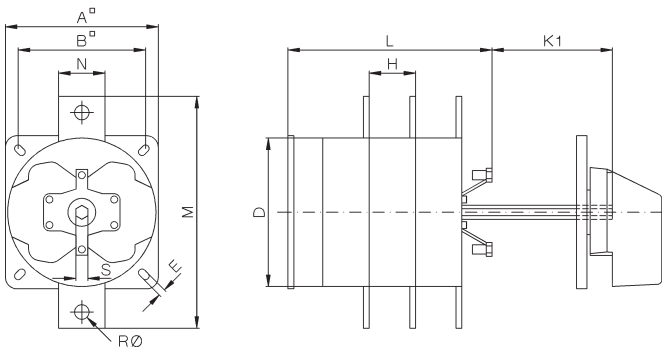

Type	A	B	C	D	D1	D2	E	G	H	K	K1	M	N	R	S
L100	86	68	7	80	6	12	5,2	3,5	18	24,5	38,5	103	27	-	SW9
L160	86	68	7	80	6	12	5,2	3,5	29,5	24,5	38,5	115	-	8,5	SW9
L400	132	110	9	128	7	16	6,2	5	40	37	104	200	40	12,5	SW12
L600	132	110	9	128	7	16	6,2	5	40	37	104	180	-	16,5	SW12
L800	132	110	9	128	7	16	6,2	5	40	37	104	240	40	16,5	SW12
L1200	132	110	9	128	7	16	6,2	5	40	37	104	240	40	16,5	SW12

Mounting holes:

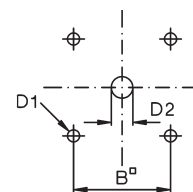

Type	Dimension L with .. cells											
	1	2	3	4	5	6	7	8	9	10	11	12
L100	52,5	70,5	88,5	106,5	124,5	142,5	160,5	178,5	196,5	214,5	232,5	250,5
L160	64	93,5	123	152,5	182	211,5	241	270,5	300	329,5	359	388,5
L400	96	136	176	216	256	296	336	376	416	456	496	536
L600	96	136	176	216	256	296	336	376	416	456	496	536
L800	96	136	176	216	256	296	336	376	416	456	496	536
L1200	96	136	176	216	256	296	336	376	416	456	496	536

Operating Knobs and Handles

Instrument knob G.

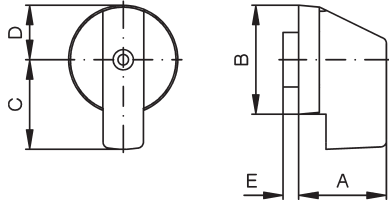

Type	A	B	C	D	E
M10, M10H, M20	23	28	24	14	4
N20, N33F	27	36	32	18	3
N40, N61, N80, L100, L160	36	47	42	24	3,5
N100, N200	48,10	75	63	37,5	-

Toggle knob K.

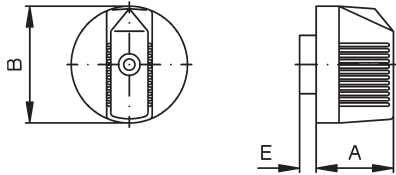

Type	A	B	E
M10, M10H, M20	18,5	28	4
N20, N33F	24	36	3

Hand wheel HR

N100, N200,
L400, L600, L800, L1200

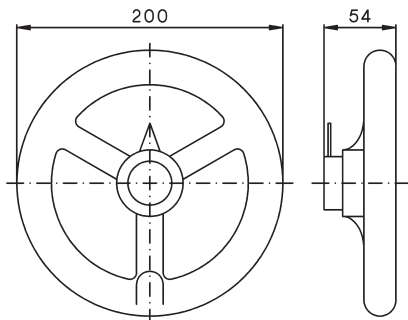

Escutcheon plates

Escutcheon plate

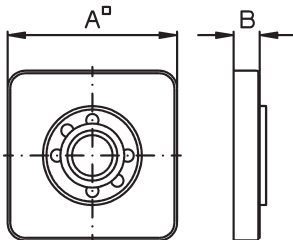

Type	A	B
M10, M10H, M20	48	7,5
N20, N33F	64	7,5
N40, N61, N80, L100, L160	88	8
N100, N200, L400, L600, L800, L1200	132	9

Rectangular additional plate SRE

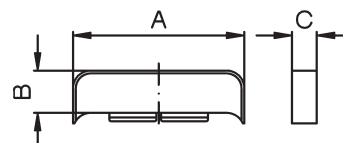

Type	A	B	C
M10, M10H, M20	48	12	7,5
N20, N33F	64	14	7,5
N40, N61, N80, L100, L160	88	22	8
N100, N200, L400, L600, L800, L1200	132	31	9

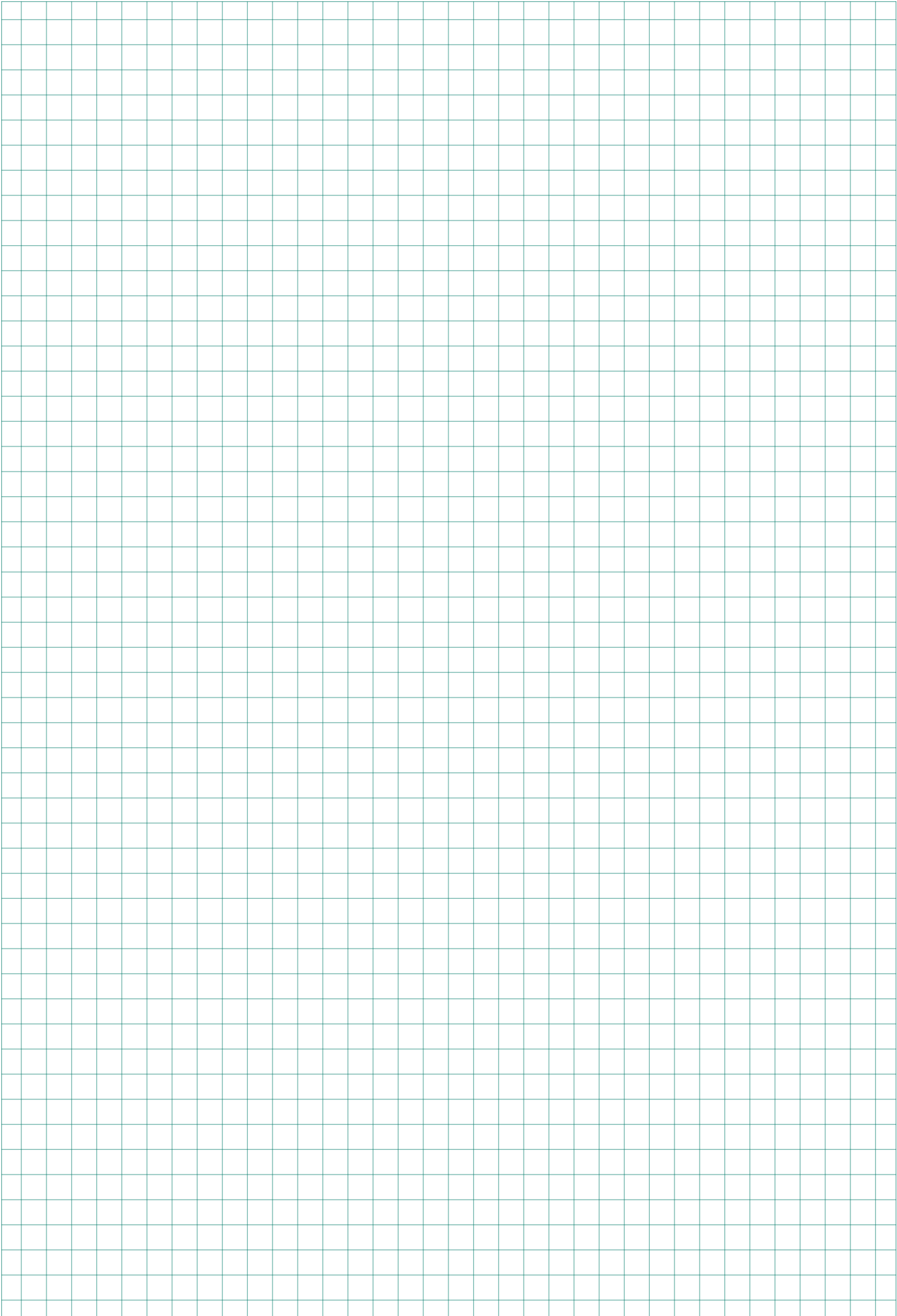

Door couplings

Dimension T is a minimum value. In case of order the dimension T is necessary.

Door coupling TK, TKFR N40 - L1200

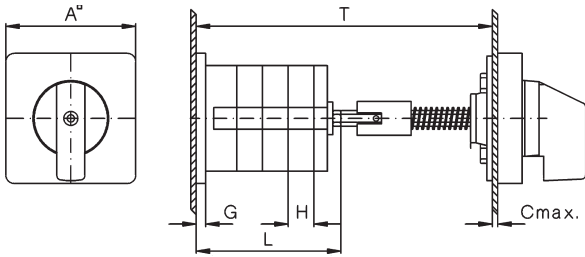

Door coupling, lockable TK2, TK2FR N40 - L1200

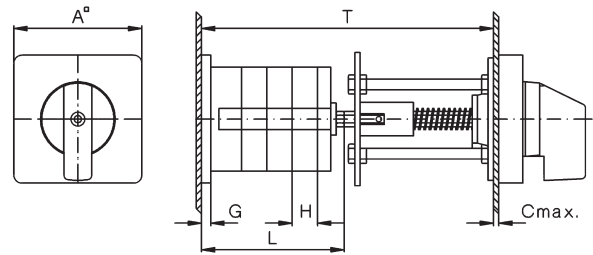

Mounting holes:
TK, TKFR, TK2, TK2FR
TKE, TK2E

Door coupling TKE, TK2E M10H, M20, N20, N33F

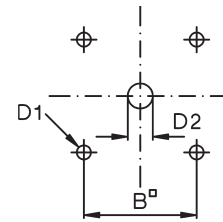
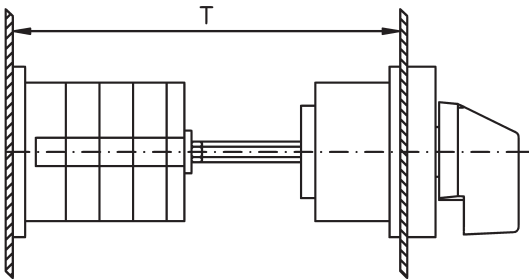

Mounting holes:
TKZ

Door coupling, lockable TK2Z M10H, M20, N20, N33F

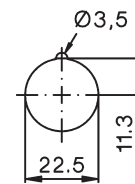
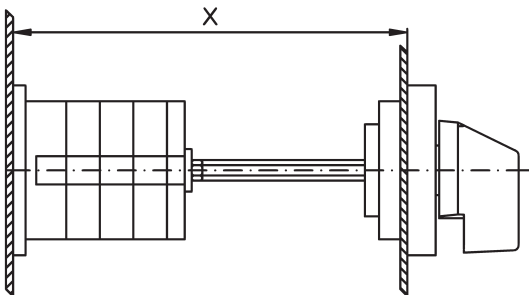

Further dimensions see pages 262 and 263.

Dimension T is a minimum value dependent on switch Type and number of cells. For ordering dimension T is necessary

Type	A	B	C	D1	D2	Minimum dimension T with .. cells							
						1	2	3	4	5	6	7	8
M10H	48	36	5	5	8	108	117,5	127	136,5	146	155,5	165	174,5
M20	48	36	5	5	8	100	112,5	125	137,5	150	162,5	175	187,5
N20	64	48	5	5	10	100	112,5	125	137,5	150	162,5	175	187,5
N33F	64	48	5	5	10	103	118,5	134	149,5	165	180,5	196	211,5
N40	88	48	7	6	12	134	152	170	188	206	224	242	260
N61	88	48	7	6	12	145,5	175	245,5	234	263,5	293	322,5	352
N80	88	48	7	6	12	145,5	175	245,5	234	263,5	293	322,5	352
N100	132	110	9	7	15	202	232	262	292	322	352	382	412
N200	132	110	9	7	15	212	252	292	332	372	412	452	492
L100	88	48	7	6	12	-	152	-	188	-	224	-	260
L160	88	48	7	6	12	145,5	175	245,5	234	263,5	293	322,5	352
L400	132	110	9	7	15	212	252	292	332	372	412	452	492
L600	132	110	9	7	15	-	-	292	-	-	412	-	-
L800	132	110	9	7	15	-	252	-	332	-	412	452	492
L1200	132	110	9	7	15	-	-	292	-	-	412	-	-

Key operated switches SA

Panel mounting E M10 - N61

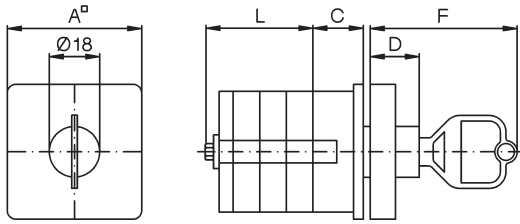

Type	A	B	C	D	D1	D2	F
M10H, M20	48	36	18	17,5	5	18,5	52,5
N20, N33F	64	48	10	17,5	5	18,5	52,5
N40, N61	88	68	23,5	15	6	18,5	50

Mounting holes

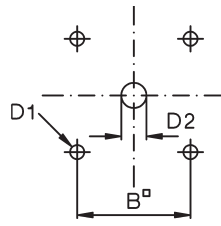

Dimension L see page 262

Base mounting V M10 - N61

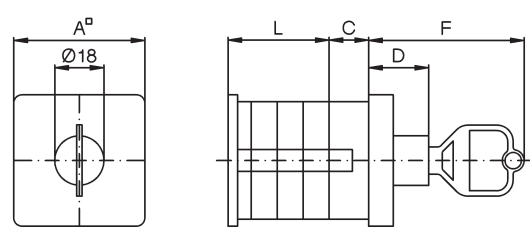

Type	A	C	D	F
M10H, M20	48	18	22	57
N20, N33F	64	8	22	57
N40, N61	88	15	15	50

Dimension L see page 263

Central fixing Z M10H Z ... + SA M20 Z ... + SA

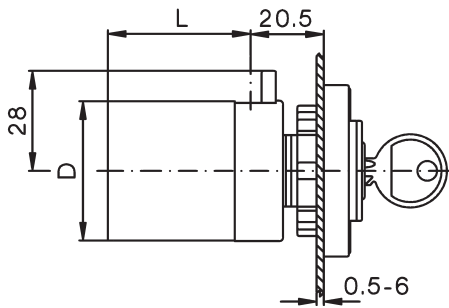

Central fixing without escutcheon plate ZO M10H ZO ... + SA M20 ZO ... + SA

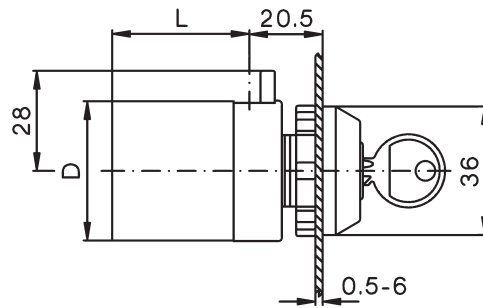

Mounting holes:

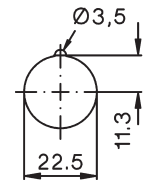

Further dimensions see page 262

DIN rail mounting SMA M10H, M20

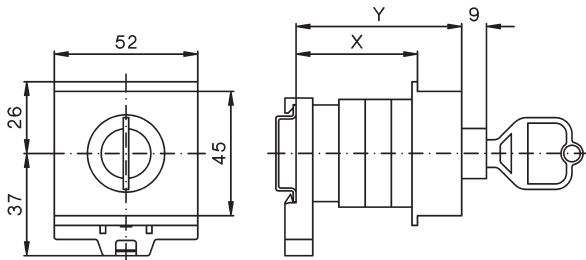

Type	Dimension X with .. cells				Dimension Y with .. cells			
	1	2	3	4	1	2	3	4
M10H	44	75	75	91	60	90	90	107
M20	59	75	75	91	75	90	90	107

Flush mounting UP M10 Plot 1:1,414

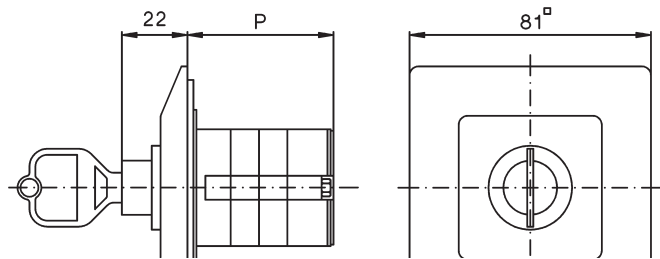

Plastic enclosed switches P, PF M10, N20, N33F, N40, N61

Type	Dimension P with .. cells			
	1	2	3	4
M10	62	71	81	90
N20	66	80	94	108
N33F	92	110	110	128
N40	92	110	-	-
N61	110	-	-	-

Further dimensions see page 264

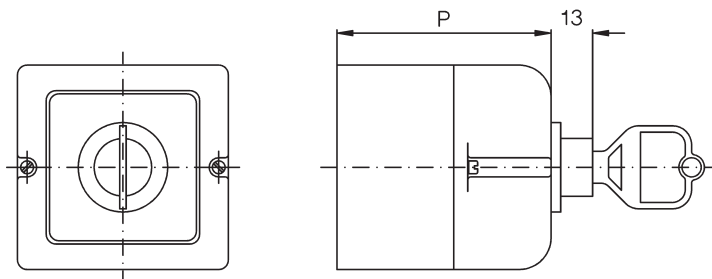

Key operated switches

Key operated switch SAK Panel mounting E M10H, M20

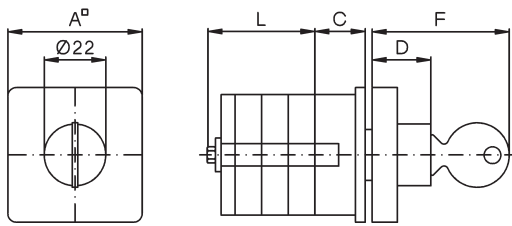

Type	A	B	C	D	D1	D2	F
M10H, M20	48	36	25	21	5	22,5	49

Mounting holes

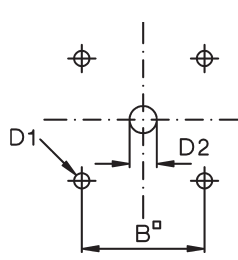

Key operated switch SAK Base mounting V M10H, M20

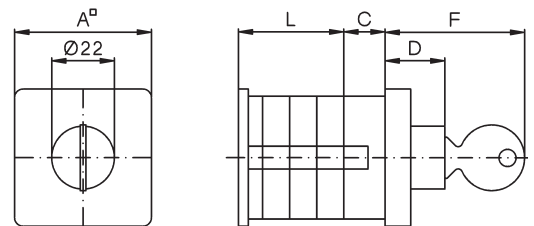

Type	A	C	D	F
M10H, M20	48	25	21	49

Key operated switch SASI Panel mounting E M10, M20

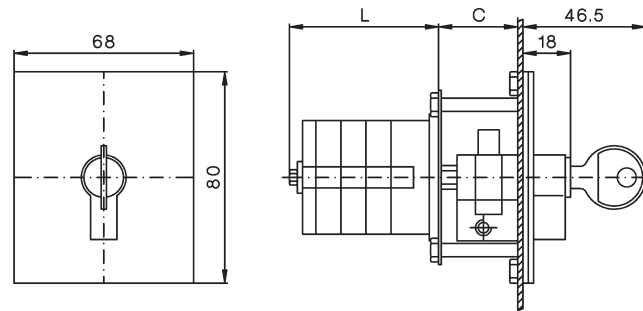

Type	M10	M20
C	20	20

Dimension L see page 263

Mounting holes M10, M20

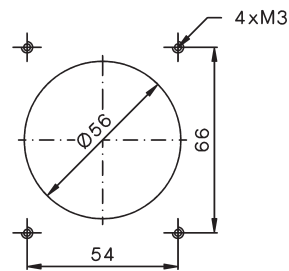

Key operated switch SASI Plastic enclosed P M10, M20

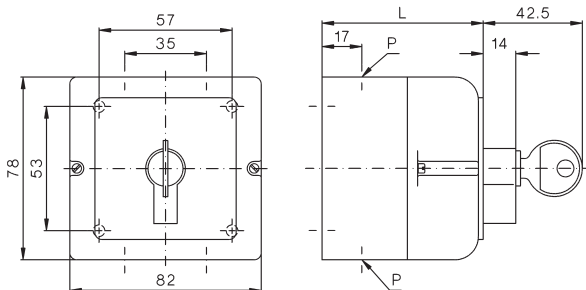

Typ	Dimension P with .. cells				P
	1	2	3	4	
M10	67	79,5	92	104,5	2xM20
M20	79,5	92	104,5	117	2xM20

Key operated switch SASI Flush mounting UP M10, M20

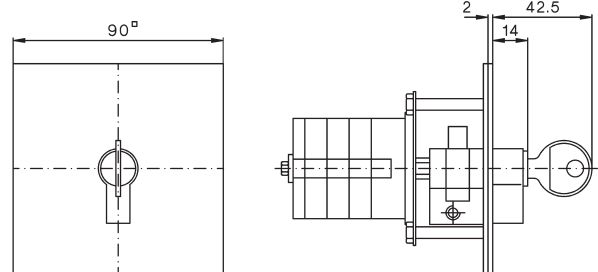

Padlock devices

Padlock device SV1 (max. 2 padlocks with stirrup $\varnothing 6\text{mm}$)
M10H, M20
Mounting holes design E, V

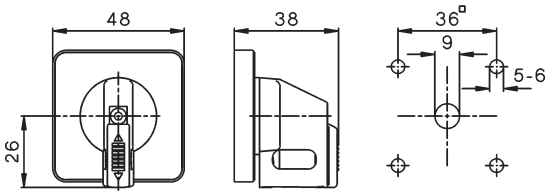

Padlock device SV164
M10H - N33F
Mounting holes design E, V

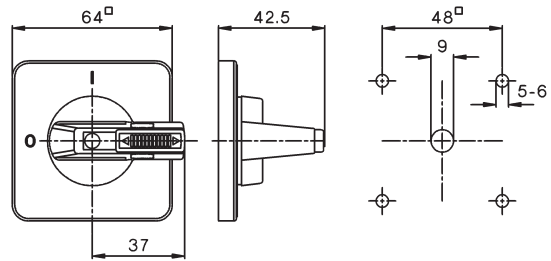

Padlock device SV3 (max. 3 padlocks with stirrup $\varnothing 8,5\text{mm}$)
Panel mounting E
N20 - N200, L100 - L1200

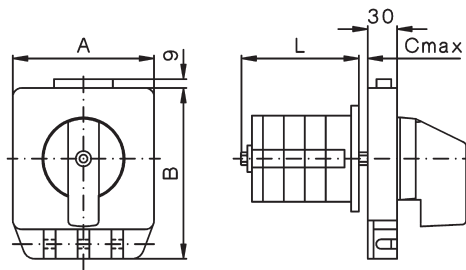

Base mounting V
N20 - N200, L100 - L1200

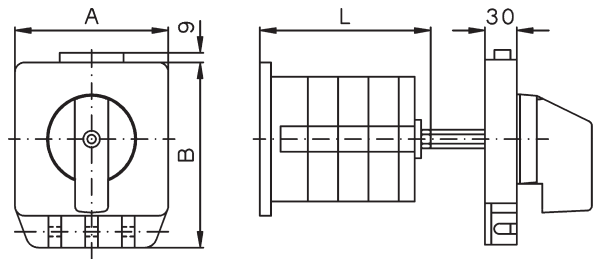

Further dimensions see page 263

Type	A	B	C
N20, N33F	102	128	5
N40, N61, N80, L100, L160	102	128	7
N100, N200, L400, L600, L800, L1200	132	159	9

Padlock device SV4 (max. 3 padlocks with stirrup $\varnothing 6\text{mm}$)
M10H - N33F
Mounting holes design E, V

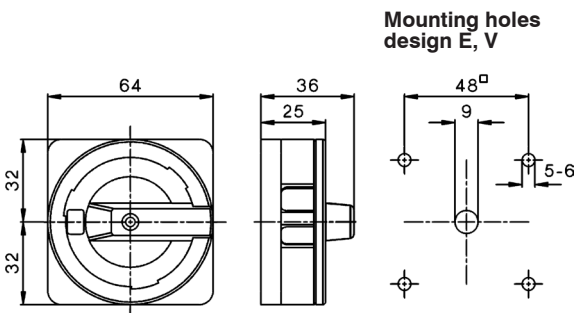

Padlock device SV4 (max. 3 padlocks with stirrup $\varnothing 6\text{mm}$)
N40 - N80, L100 - L160
Padlock device SV488
N20, N33F
Mounting holes design E, V

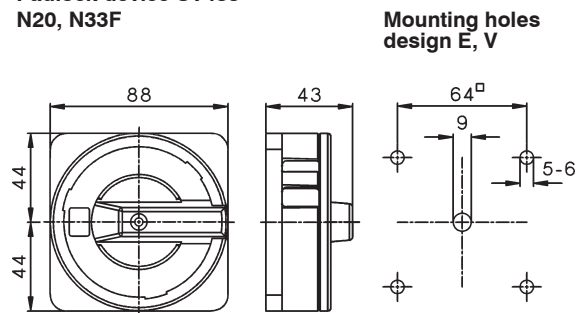

Front plate/switch shaft sealing FPWD
N20, N33F

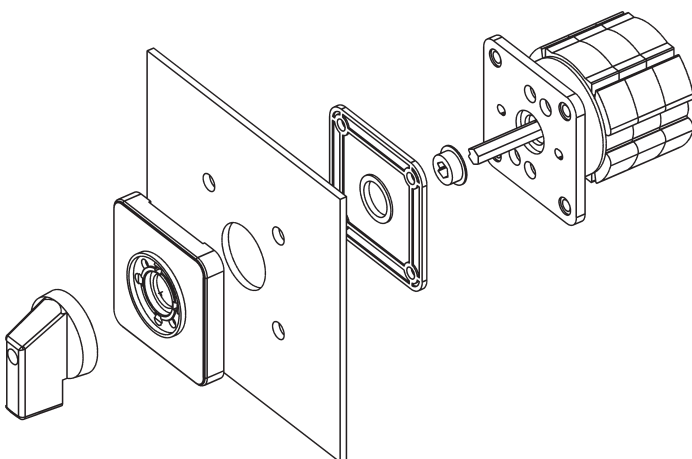

Mounting holes

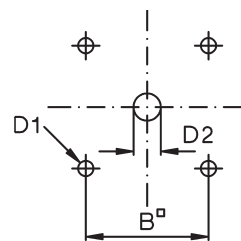

Typ	B	D1	D2
N20, N33F	48	5	17

Interlocks, Moisture caps

Lock switch SZ, SZ2 Panel mounting E

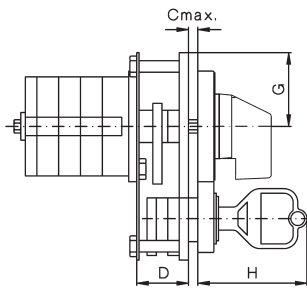
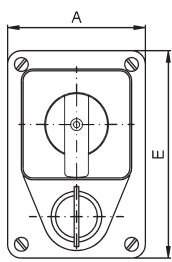

Base mounting V

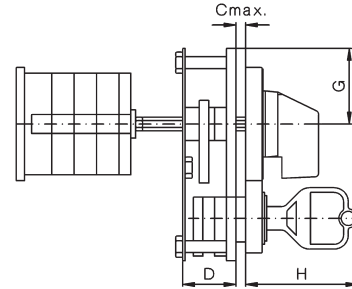
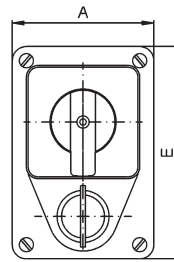

Mounting holes

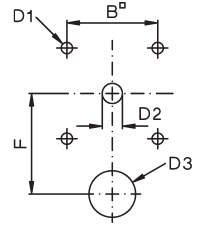

Type	A	B	C	D	D1	D2	D3	E	F	G	H
M10H, M20	60	36	3	22,5	5	8	18,5	90	40	32	47,5
N20, N33F	60	36	3	22,5	5	12	18,5	90	45	32	47,5
N40, N61, N80, L100, L160	90	68	4	24	6	12	18,5	142	61	61,5	48
N100, N200, L400, L600, L800, L1200	140	110	4	27	7	15	18,5	180	83	90,5	49

Push-button switch lock DV Switch interlock with electrical contact ET Panel mounting E

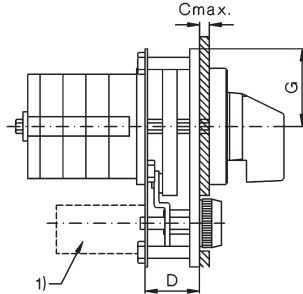
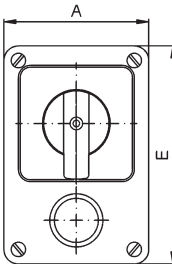

Base mounting V

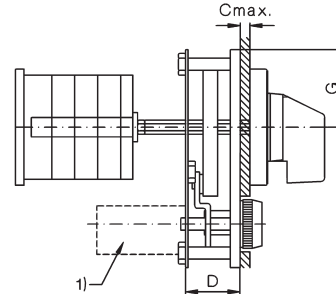
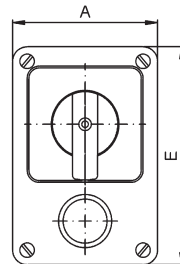

Mounting holes

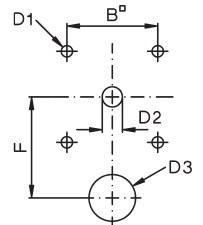

Type	A	B	C	D	D1	D2	D3	E	F	G
M10H, M20	60	36	3	22,5	5	8	26	90	45	32
N20, N33F	60	36	3	22,5	5	10	26	90	45	32
N40, N601 N80, L100, L160	90	68	4	25	6	12	29	142	61	61,5
N100, N200, L400, L600, L800, L1200	140	110	4	41	7	15	29	180	83	90,5

1) only at +ET

Moisture proofing caps for panel switches FR M10H

Type	Dimension L with .. cells						
	1	2	3	4	5	6	7
M10H	55	55	75	75	88	106	106

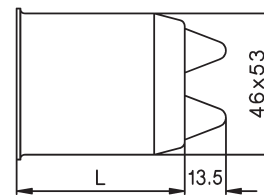
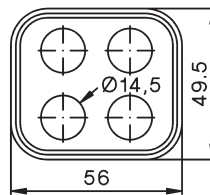

Moisture proofing caps for panel switches FR N20, N40, N61

Type	A	B	D	E	Dimension L with .. cells				
					1	2	3	4	5
N20	60	48	59	5,5	68	68	68	91	91
N40	87	68	83	5,5	82	82	117	117	-

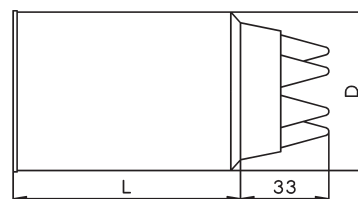
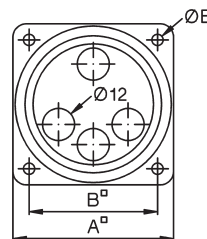

Fire Brigade Switch

Neon safety switch N20 E .. +FEU, N33F E .. +FEU

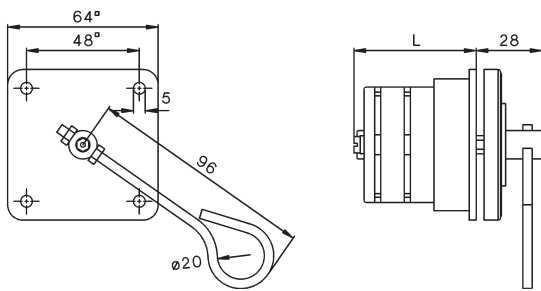

Further dimensions see pages 262

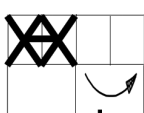
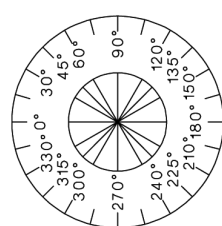
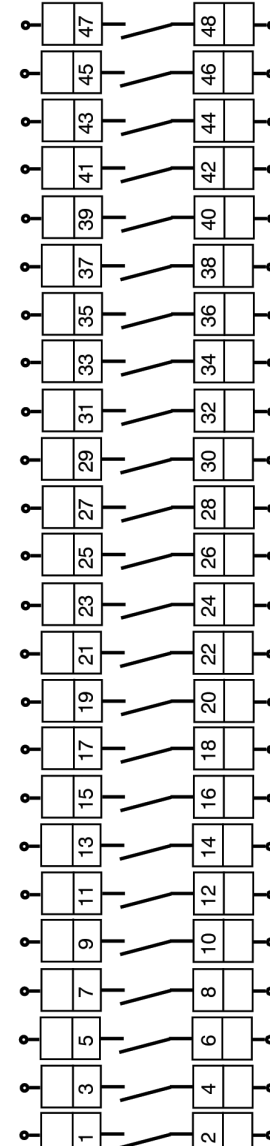
<p>Order sheet D399E</p> <table border="1" style="width:100%; border-collapse: collapse;"> <tr><td style="width: 20%;">Switch Type</td><td></td></tr> <tr><td>M4H</td><td></td></tr> <tr><td>M10</td><td></td></tr> <tr><td>M10H</td><td></td></tr> <tr><td>M10HD</td><td></td></tr> <tr><td>M20</td><td></td></tr> <tr><td>N20</td><td></td></tr> <tr><td>N33F</td><td></td></tr> <tr><td>N40</td><td>L400</td></tr> <tr><td>N61</td><td>L600</td></tr> <tr><td>N80</td><td>L800</td></tr> <tr><td>N100</td><td>L1200</td></tr> <tr><td>N200</td><td></td></tr> </table> <p>Design</p> <p>Panel mounting E</p> <p>Central fixing Z</p> <p style="padding-left: 20px;">ZO</p> <p>Base mounting V</p> <p>Snap-on mount. SM</p> <p style="padding-left: 20px;">SMA</p> <p>Plastic enclosure P</p> <p>IP54 PF</p>	Switch Type		M4H		M10		M10H		M10HD		M20		N20		N33F		N40	L400	N61	L600	N80	L800	N100	L1200	N200		<p style="text-align: center;">Cam switches with special switching program</p> <p style="text-align: center;">Benedict GmbH</p> <p>A-1220, Vienna, Lieblgasse 7 Tel.: 251 51-0 Fax: 251 51-88</p> <p>Customer:</p>	<p>Handles</p> <table border="1" style="width:100%; border-collapse: collapse;"> <tr><td>Instrument knob</td><td>G (standard)</td><td>Handle colour</td><td>black (standard)</td></tr> <tr><td>Twist knob</td><td>R (standard N40 ->)</td><td></td><td>red</td></tr> <tr><td>Toggle knob</td><td>K (standard SMA)</td><td></td><td>grey (standard SMA)</td></tr> <tr><td>Ball type handle</td><td>B</td><td></td><td>white</td></tr> <tr><td>Hand wheel</td><td>HR</td><td></td><td>cream-coloured</td></tr> <tr><td></td><td></td><td></td><td>yellow</td></tr> <tr><td></td><td></td><td></td><td>blue</td></tr> </table>	Instrument knob	G (standard)	Handle colour	black (standard)	Twist knob	R (standard N40 ->)		red	Toggle knob	K (standard SMA)		grey (standard SMA)	Ball type handle	B		white	Hand wheel	HR		cream-coloured				yellow				blue	<p>Explanations:</p> <p>Contact closed over several positions</p> <p>Spring return from pos.</p> 
Switch Type																																																									
M4H																																																									
M10																																																									
M10H																																																									
M10HD																																																									
M20																																																									
N20																																																									
N33F																																																									
N40	L400																																																								
N61	L600																																																								
N80	L800																																																								
N100	L1200																																																								
N200																																																									
Instrument knob	G (standard)	Handle colour	black (standard)																																																						
Twist knob	R (standard N40 ->)		red																																																						
Toggle knob	K (standard SMA)		grey (standard SMA)																																																						
Ball type handle	B		white																																																						
Hand wheel	HR		cream-coloured																																																						
			yellow																																																						
			blue																																																						
																																																									
<p>Marking for switch positions</p>		<p>Degree</p>																																																							
<p>Optional extras</p>		<p>Circular switch</p>																																																							
<p>Key removeable</p>																																																									

